

SF2098E

**915 MHz
SAW Filter**

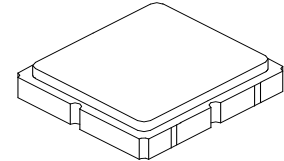

SM3030-6

- **Low-loss 915 MHz SAW Filter**
- **Designed for 50 ohm Source/Load**
- **Complies with Directive 2002/95/EC (RoHS)**
- **Moisture Sensitivity Level: 1**

Absolute Maximum Ratings

Rating	Value	Units
Input Power Level	+15	dBm
DC Voltage on any Non-ground Terminal	5	V
Operating Temperature Range	-40 to +125	°C
Component Storage Temperature Range	-40 to +125	°C
Storage Temperature Range in Tape and Reel	-40 to +85	°C
Maximum Soldering Profile, 5 cycles/10 seconds maximum	265	°C
Temperature Coefficient of Frequency	-36	ppm/°C

Electrical Characteristics

Characteristic (Operating Temperature -40°C to +85°C)	Sym	Notes	Min	Typ	Max	Units
Center Frequency	f_c			915		MHz
Insertion Loss, 902 to 928 MHz	IL			1.9	4.0	0
Amplitude Ripple, 902 to 928 MHz				1.0	3.2	dB
VSWR, 902 to 928 MHz				1.8:1	2.2:1	
Attenuation, Referenced to 0 dB:						dB
10 to 800 MHz			35	37		
800 to 888 MHz at 25°C			36	38		
800 to 888 MHz at -40°C to +85°C			29	38		
888 to 890 MHz 25°C			24	31		
888 to 890 MHz at -40°C to +85°C			22	31		
890 to 894 Mhz			5	18		
940 to 941 MHz			27	47		
941 to 967 MHz			35	49		
967 to 1350 MHz			37	39		
1350 to 1600 MHz			35	42		
1600 to 2000 MHz			30	45		
2000 to 2500 MHz			28	35		
Source Impedance	Z_s			50		Ω
Load Impedance	Z_L			50		Ω
Case Style	SM3030-6 3.0 x 3.0 mm Nominal Footprint					
Lid Symbolization (Y=year, WW=week, S=shift) dot=pin 1 indicator	A66, <u>YWWS</u>					



CAUTION: Electrostatic Sensitive Device. Observe precautions for handling.

NOTES:

1. The design, manufacturing process, and specifications of this device are subject to change.
2. US or International patents may apply.
3. RoHS compliant from the first date of manufacture.

Electrical Characteristics

Characteristic (Operating Temperature -40°C to +125°C)	Sym	Notes	Min	Typ	Max	Units
Center Frequency	f_c			915		MHz
Insertion Loss, 902 to 928 MHz	IL			1.9	4.5	dB
Amplitude Ripple, 902 to 928 MHz				1.0	3.7	dB
VSWR, 902 to 928 MHz				1.8:1	2.5:1	
Attenuation, Referenced to 0 dB:						dB
10 to 800 MHz			35	37		
800 to 888 MHz at 25°C			36	38		
800 to 888 MHz at -40°C to +125°C			15	38		
888 to 890 MHz 25°C			24	31		
888 to 890 MHz at -40°C to +125°C			10	31		
940 to 941 MHz			27	47		
941 to 967 MHz			35	49		
967 to 1350 MHz			37	39		
1350 to 1600 MHz			35	42		
1600 to 2000 MHz			30	45		
2000 to 2500 MHz			28	35		
Source Impedance	Z_S			50		Ω
Load Impedance	Z_L			50		Ω

Electrical Connections

Connection	Terminals
Input	2
Output	5
Case Ground	All others

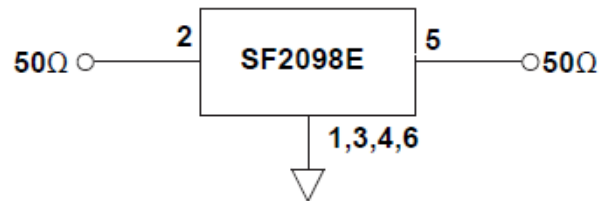

Filter Response Plots

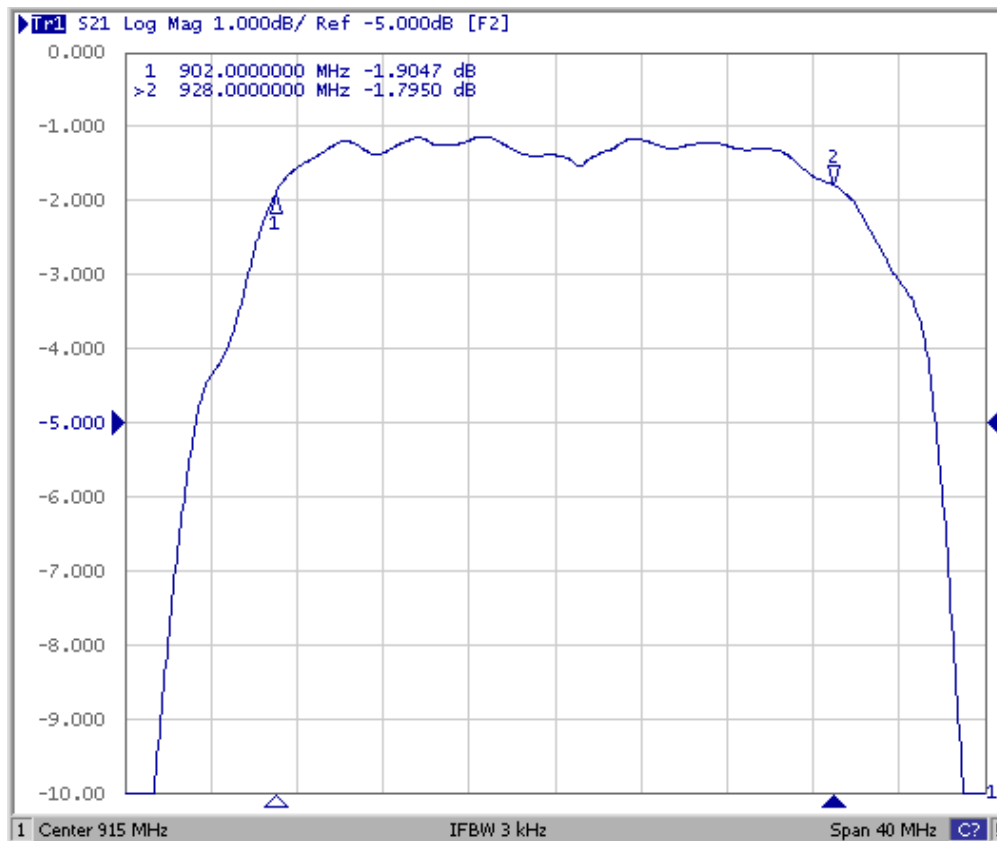
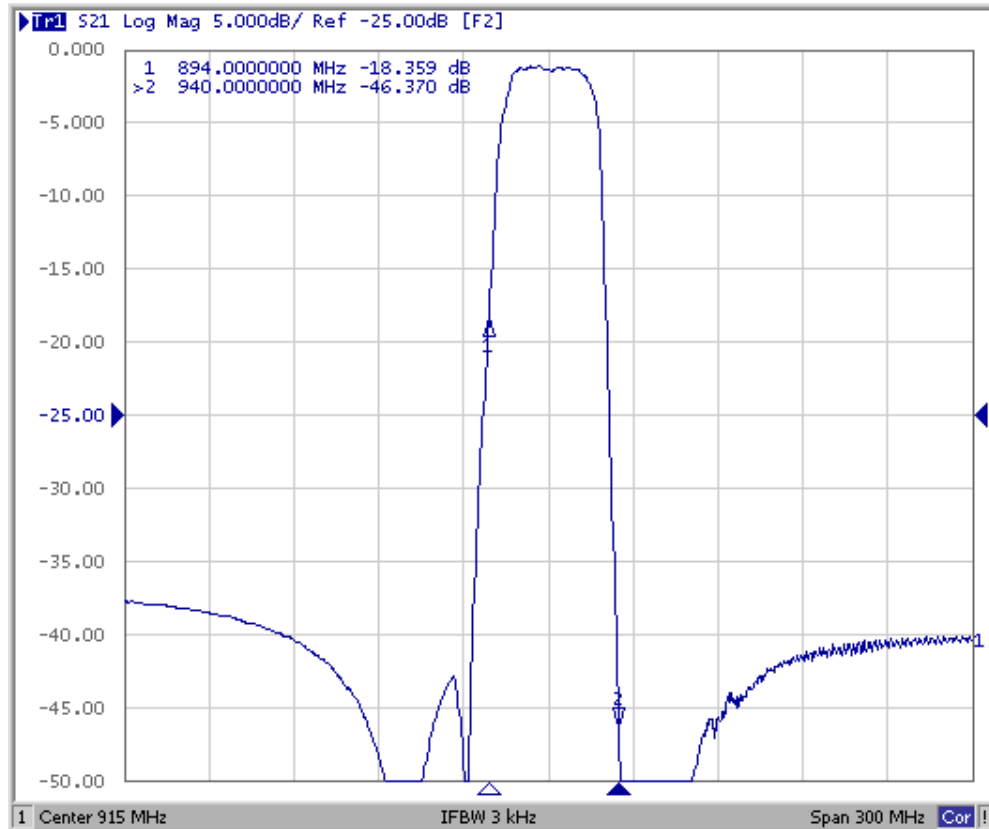

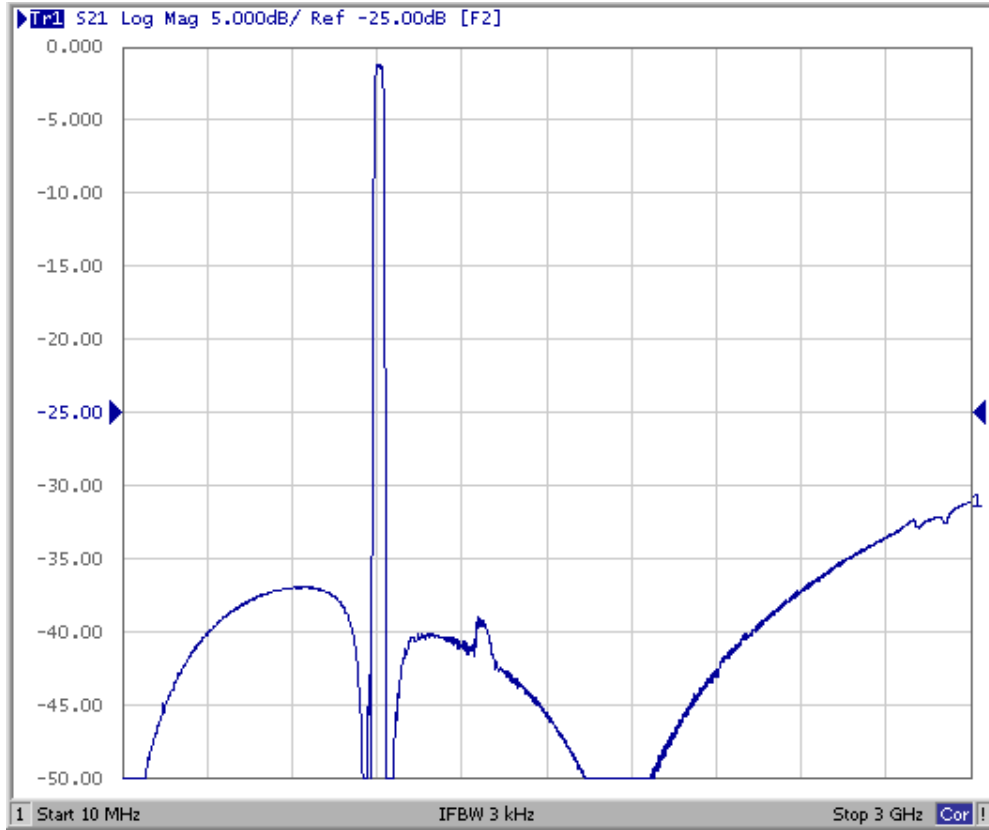

Filter SWR Plots

S11

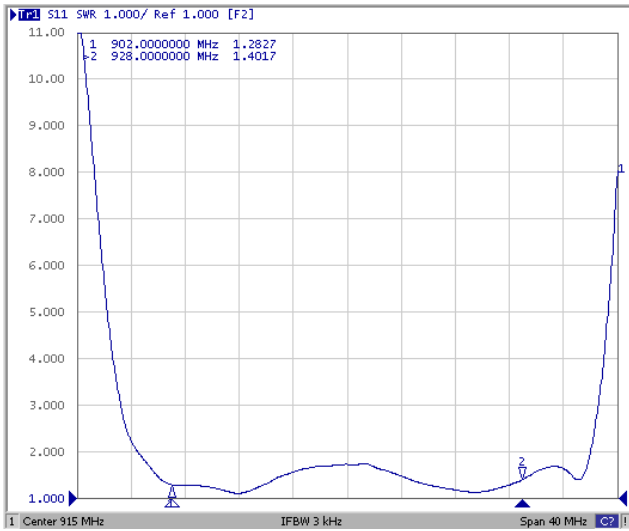

S22

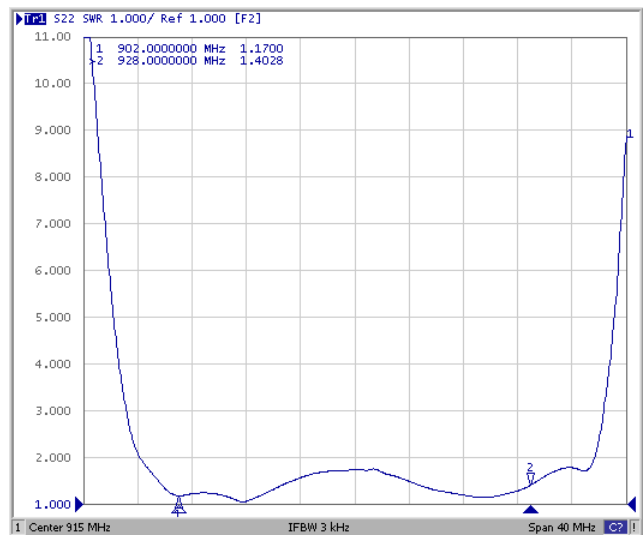

SM3030-6 Case

6-Terminal Ceramic Surface-Mount Case 3.0 X 3.0 mm Nominal Footprint

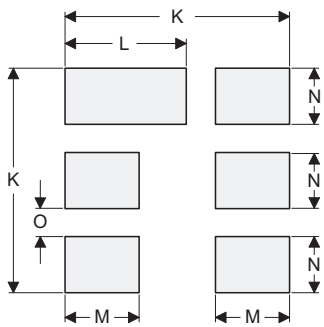
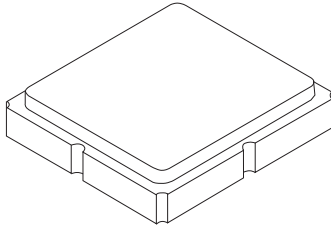

PCB Footprint Top View

Case and PCB Footprint Dimensions

Dimension	mm			Inches		
	Min	Nom	Max	Min	Nom	Max
A	2.87	3.00	3.13	0.113	0.118	0.123
B	2.87	3.00	3.13	0.113	0.118	0.123
C	1.12	1.25	1.38	0.044	0.049	0.054
D	0.77	0.90	1.03	0.030	0.035	0.040
E	2.67	2.80	2.93	0.105	0.110	0.115
F	1.47	1.60	1.73	0.058	0.063	0.068
G	0.72	0.85	0.98	0.028	0.033	0.038
H	1.37	1.50	1.63	0.054	0.059	0.064
I	0.47	0.60	0.73	0.019	0.024	0.029
J	1.17	1.30	1.43	0.046	0.051	0.056
K		3.20			0.126	
L		1.70			0.067	
M		1.05			0.041	
N		0.81			0.032	
O		0.38			0.015	

Case Materials

Materials	
Solder Pad Plating	0.3 to 1.0 μm Gold over 1.27 to 8.89 μm Nickel
Lid Plating	2.0 to 3.0 μm Nickel
Body	Al_2O_3 Ceramic

Electrical Connections

Connection	Terminals
Input	2
Output	5
Case Ground	All others

TOP VIEW

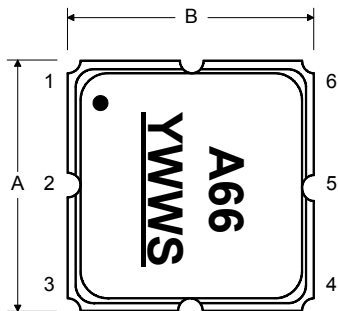

BOTTOM VIEW

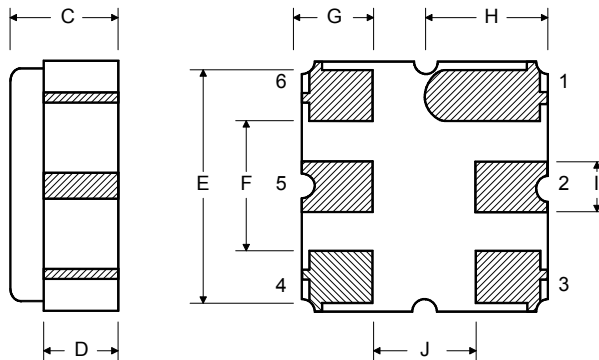

Tape and Reel Specifications

Tape and Reel Standard per ANSI/EIA-481

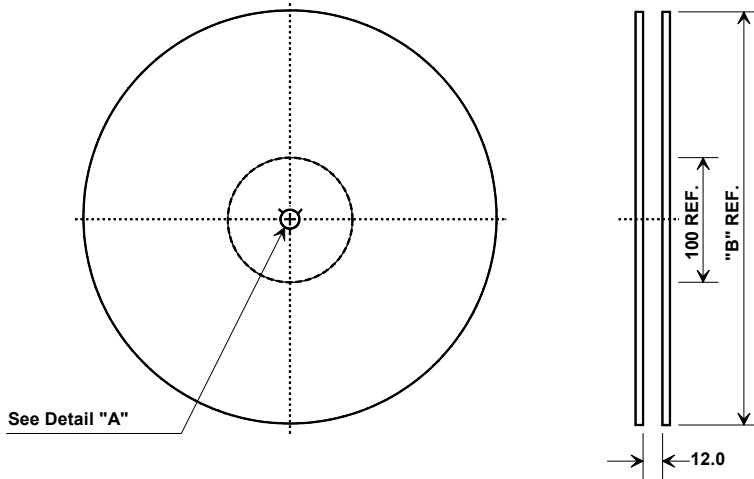

"B"		Quantity Per Reel
Inches	millimeters	
7	178	500
13	330	3000

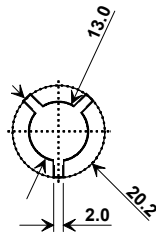

COMPONENT ORIENTATION and DIMENSIONS

Carrier Tape Dimensions	
Ao	3.35 mm
Bo	3.35 mm
Ko	1.40 mm
Pitch	8.0 mm
W	12.0 mm

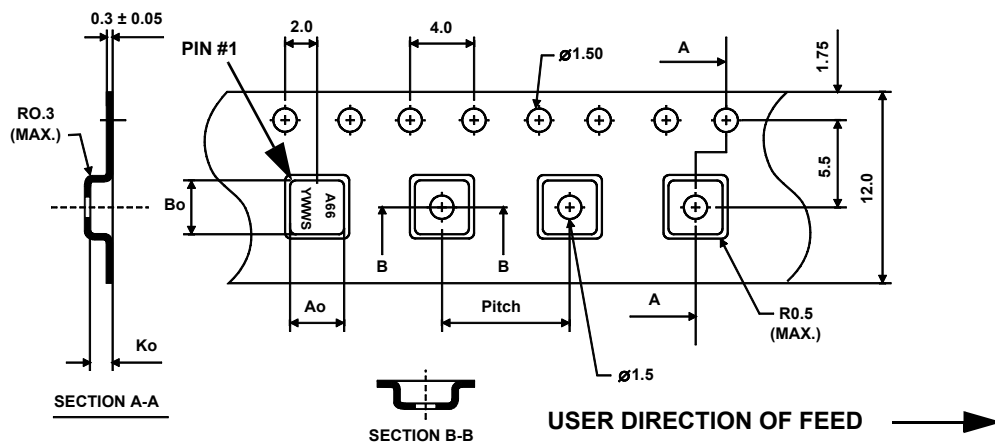

Recommended Reflow Profile

1. Preheating shall be fixed at 150~180°C for 60~90 seconds.
2. Ascending time to preheating temperature 150°C shall be 30 seconds min.
3. Heating shall be fixed at 220°C for 50~80 seconds and at 260°C+0/-5°C peak (10 seconds).
4. Time: 5 times maximum.

