

Ceramic Monopole Antenna

Ground cleared under antenna. Pulse Part Number: W3000



Features

- Multipurpose for various frequencies
- Omni directional radiation
- Low profile
- Compact size W x L x H (7 x 1.6 x 1.6 mm)
- Low weight (86 mg)
- Lead free materials
- Fully SMD compatible
- Lead free soldering compatible
- Tape and reel packing
- RoHS compliant product
- MSL 1

Applications

- Bluetooth, WLAN, WiFi
- IEEE 802.11b/g
- ZigBee IEEE 802.15.4
- 2.4 GHz WLAN
- 2.4 GHz ISM Band System
- 868 MHz ISM Band Systems
- GPS 1.575 GHz

Electrical specifications @ +25 °C

Note: Electrical characteristics depend on test board (GP) size and antenna positioning on GP and ground clearance area size. Matching and tuning circuit component values are case depended.

Pulse Finland Oy

Takatie 6
90440 Kempele, Finland
Tel: +358 207 935 500
Fax: +358 207 935 501
www.pulseeng.com/antennas

Ceramic Monopole Antenna

Ground cleared under antenna. Pulse Part Number: W3000

Monopole 1.575 GHz

Typical performance

Board	Frequency Range [MHz]	Avg Gain [dBi]	Max Gain [dBi]	Efficiency [%] / [dB]	Return loss min. [dB]	Impedance [Ω]	Operating Temperature [$^{\circ}$ C]
Case #1 11x40mm	1565 – 1585	-3.5 (Peak) -3.9 (Band edges)	0.1 (Peak) -0.2 (Band edges)	50/-3 (Peak) 45/-3.5 (Band edges)	-12	50	-40 to +85
Case #2 20x30mm		-3.9 (Peak) -4.1 (Band edges)	0.3 (Peak) 0 (Band edges)	50/-3 (Peak) 45/-3.5 (Band edges)	-15		
Case #3 37x80mm		-2.7 (Peak) -2.9 (Band edges)	2.0 (Peak) 1.7 (Band edges)	70/-1.55 (Peak) 65/-1.9 (Band edges)	-18		

Monopole 2.4 GHz

Typical performance

Board	Frequency Range [MHz]	Avg Gain [dBi]	Max Gain [dBi]	Efficiency [%] / [dB]	Return loss min. [dB]	Impedance [Ω]	Operating Temperature [$^{\circ}$ C]
Case #1 11x40mm	2400 – 2483.5	-4.1 (Peak) -3.7 (Band edges)	1.4 (Peak) 1.9 (Band edges)	65/-0.3 (Peak) 55/-0.6 (Band edges)	-18	50	-40 to +85
Case #2 20x30mm		-4.0 (Peak) -4.3 (Band edges)	2.2 (Peak) 1.5 (Band edges)	52/-2.9 (Peak) 46/-3.4 (Band edges)	-12		

ISM 868 MHz

Typical performance

Board	Frequency Range [MHz]	Avg Gain [dBi]	Max Gain [dBi]	Efficiency [%] / [dB]	Return loss min. [dB]	Impedance [Ω]	Operating Temperature [$^{\circ}$ C]
Case #1 20x40mm Vertical	858 – 878	-6.5 (Peak) -7 (Band edges)	-1.8 (Peak) -2.5 (Band edges)	29/-5.4 (Peak) 25/-6 (Band edges)	-10	50	-40 to +85
Case #2 20x40mm Horizontal		-6.5 (Peak) -6.8 (Band edges)	-1.4 (Peak) -2 (Band edges)	30/-5.3 (Peak) 28/-5.55 (Band edges)			

Pulse Finland Oy

Takatie 6
90440 Kempele, Finland
Tel: +358 207 935 500
Fax: +358 207 935 501

www.pulseeng.com/antennas



Ceramic Monopole Antenna

Ground cleared under antenna. Pulse Part Number: W3000

Terminal Configuration and Dimensions

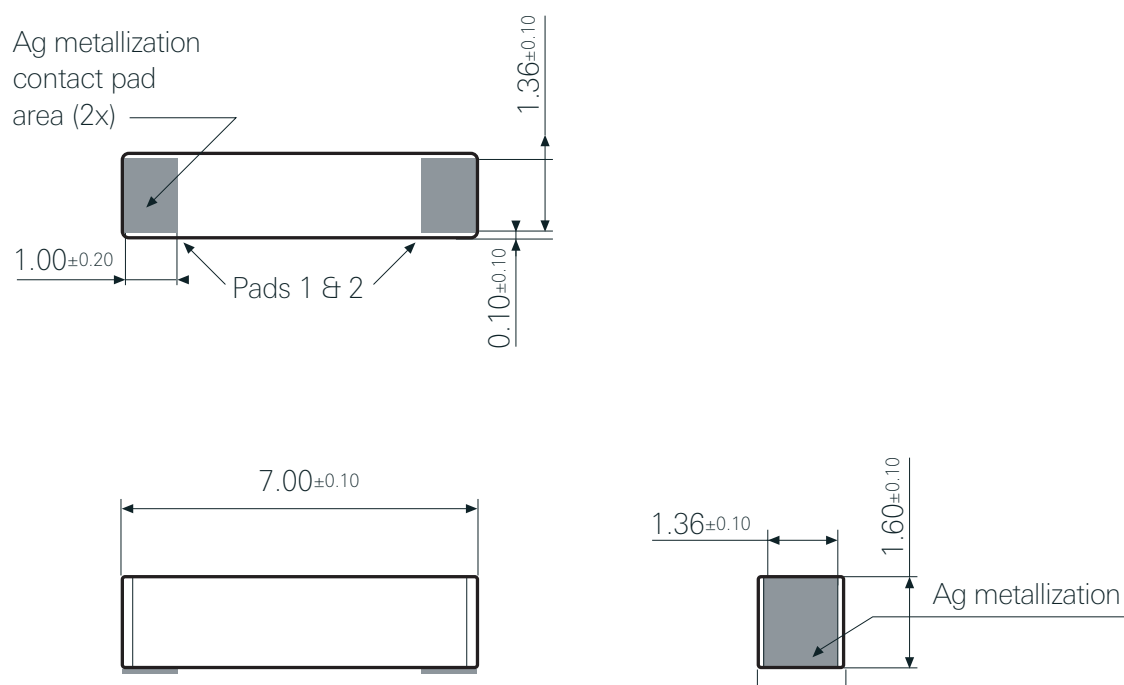

Antenna features

No.	Terminal name	Terminal Dimensions
1	Feed / GND	1.00 x 1.36 mm
2	Feed / GND	1.00 x 1.36 mm

Antenna is symmetrical.

Either of terminals 1 or 2 can be feed / GND

Pulse Finland Oy

Takatie 6
 90440 Kempele, Finland
 Tel: +358 207 935 500
 Fax: +358 207 935 501
www.pulseeng.com/antennas

Ceramic Monopole Antenna

Ground cleared under antenna. Pulse Part Number: W3000

Packing Form

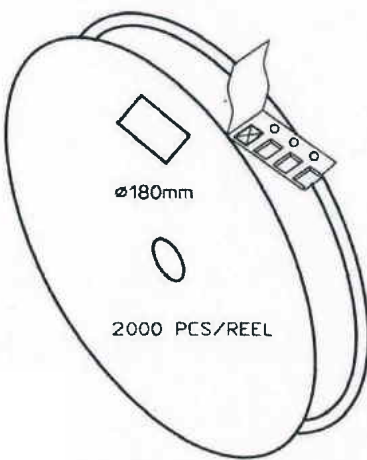

∅180mm
2000 PCS/REEL

CARRIER TAPE H85-00192
width=16,00 depth=1.70
COVER TAPE H85-00193
width=13.40

LENGTH OF TAPE:

- Leader section: min 350 mm before component section
- Trailer section: min 40 mm after component section.

Empty part cavities at leader and trailer section of the tape must be sealed with top cover tape.

BOX H85-00128 1 pcs
(182x182x125)
- LABEL 1 pcs/BOX

REEL H85-00164 6 pcs
(D180, W28)
- REEL LABEL 1 pcs/REEL

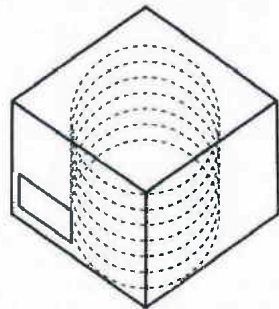

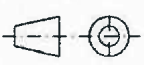
MATERIAL					
HANDLINGS					
		RATIO	DRWN	161007 PeHa	H
			DGNER		G
			CHKD		F
			APPRD		E
			APPRD BY		D
PRODUCT					C
H90-OY838					B
DENOMINATION					A
PACKING FORM			VERSION		MOD/DATE/NAME

Pulse Finland Oy

Takatie 6
90440 Kempele, Finland
Tel: +358 207 935 500
Fax: +358 207 935 501

www.pulseeng.com/antennas



Ceramic Monopole Antenna

Ground cleared under antenna. Pulse Part Number: W3000

Antenna PWB Layout Specifications

Ground cleared under antenna, clearance area 11.00 x 6.00 mm

Matching and tuning component values depend on application and surrounding mechanics / materials.
Feed line should be designed to match 50 Ω characteristic impedance, depending on PWB material and thickness.
Recommended test board layout for electrical characteristic measurement, test board outline size 11 x 40 mm.
Recommended PWB manufacturing tolerances according to standard: IPC-A-600, revision G

PWB layout for W3000 Monopole Antenna

Note: All dimensions are in metric system.

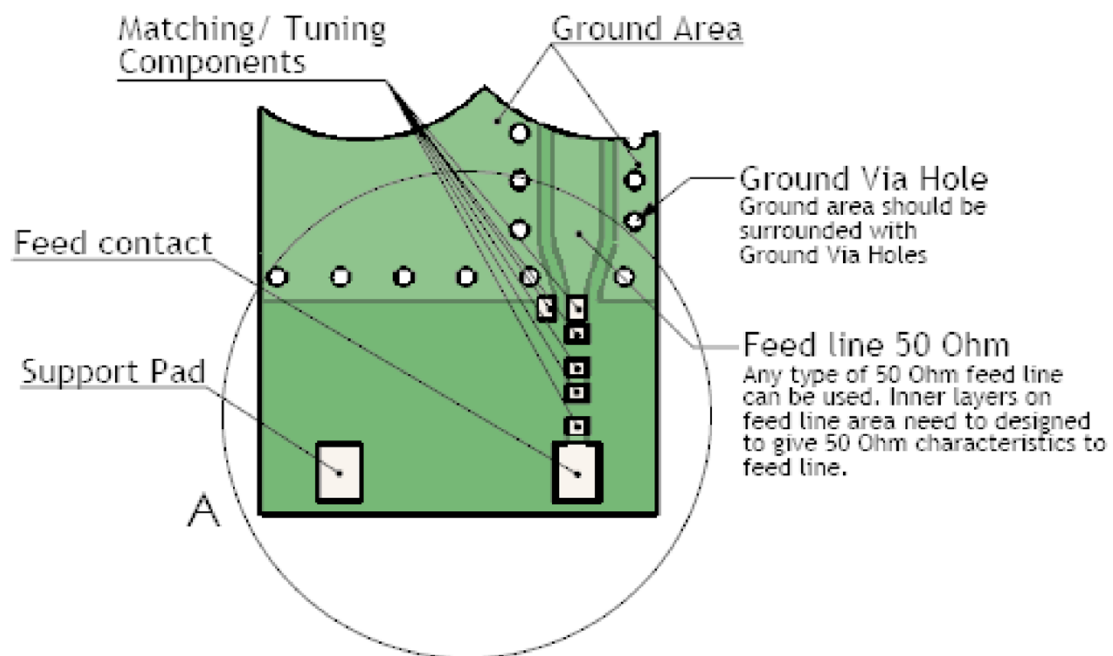

Ceramic Monopole Antenna

Ground cleared under antenna. Pulse Part Number: W3000

PWB Pad Dimensions

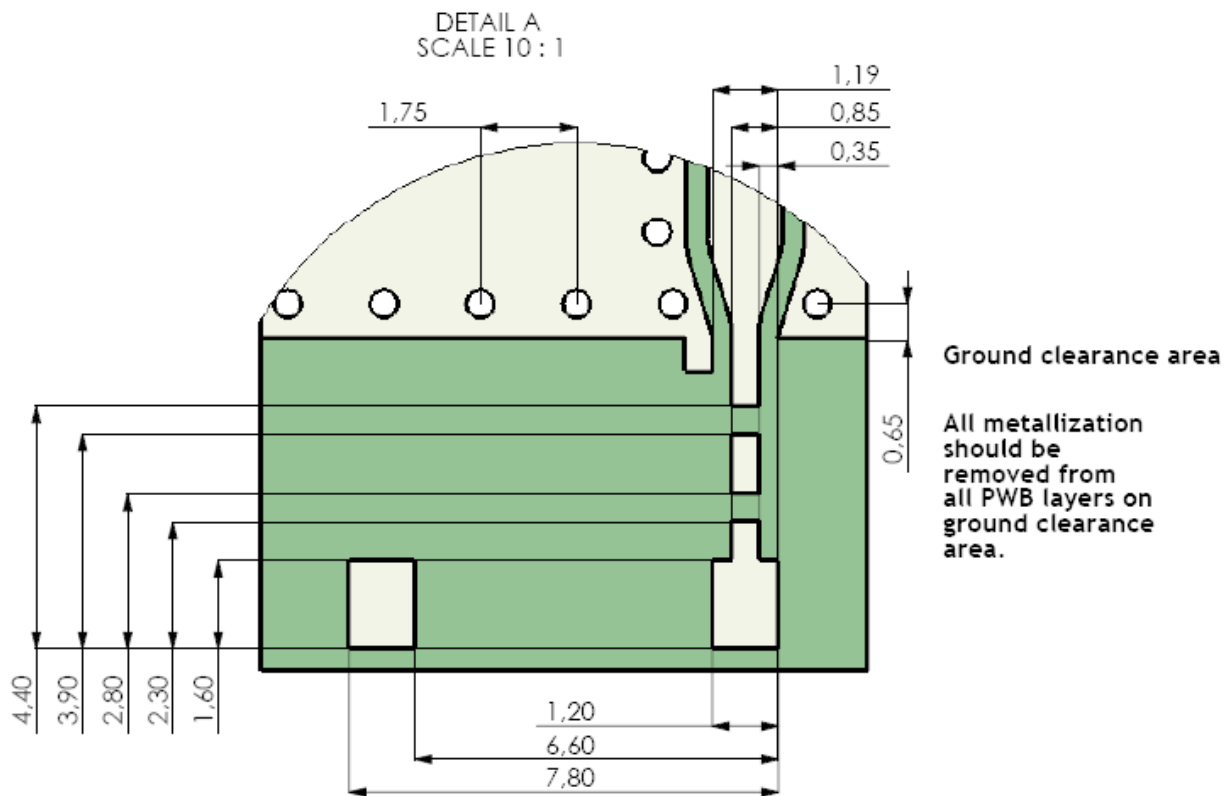

Pulse Finland Oy

Takatie 6
90440 Kempele, Finland
Tel: +358 207 935 500
Fax: +358 207 935 501
www.pulseeng.com/antennas

Ceramic Monopole Antenna

Ground cleared under antenna. Pulse Part Number: W3000

GPS Antenna Case #1

Board Size 40 x 11 mm

Recommended antenna position on PWB for W3000 MONOPOLE Antenna

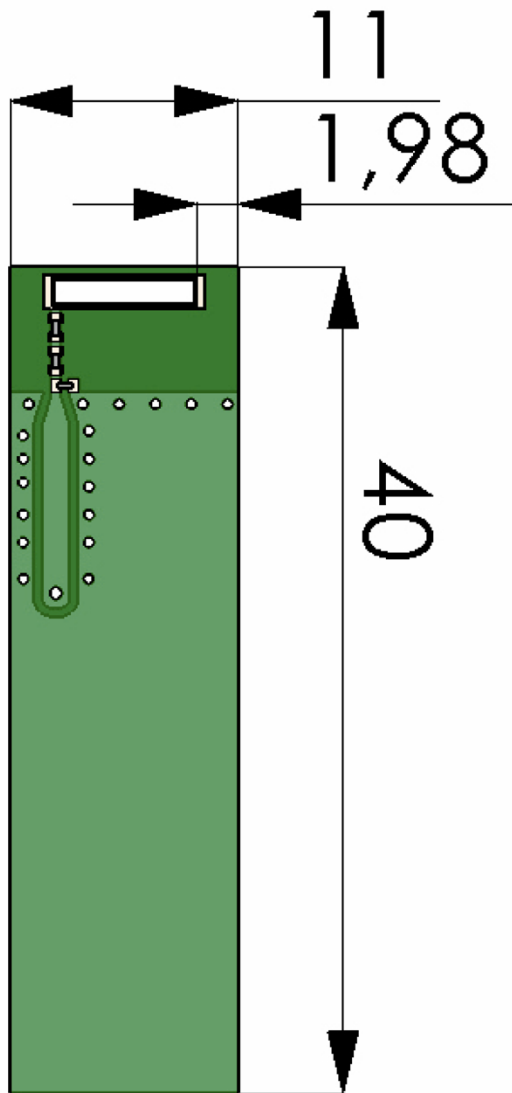

Pulse Finland Oy

Takatie 6
90440 Kempele, Finland

Tel: +358 207 935 500

Fax: +358 207 935 501

www.pulseeng.com/antennas

Ceramic Monopole Antenna

Ground cleared under antenna. Pulse Part Number: W3000

GPS Antenna Case #1, Test Set Up and Measurement Performance

Ground cleared under antenna, clearance area 11.00 x 6.00 mm.

Typical Electrical Characteristics (T=25 °C)

Measured on the 11 x 40 mm test board with matching circuit. Measured in antenna position1 on PWB layout, see previous page. Typical Return Loss S11/ impedance, free space efficiency and gain.

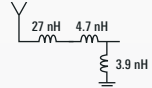

GPS 1.575 GHz Case #1

11 Feb 2009 11:44:05

CH1 Markers

- 1. -16.052 dB 1.56550 GHz
- 2. -15.252 dB 1.57500 GHz
- 3. -13.199 dB 1.58500 GHz

CH1 S11&MLOG

5 dB/REF 0 dB

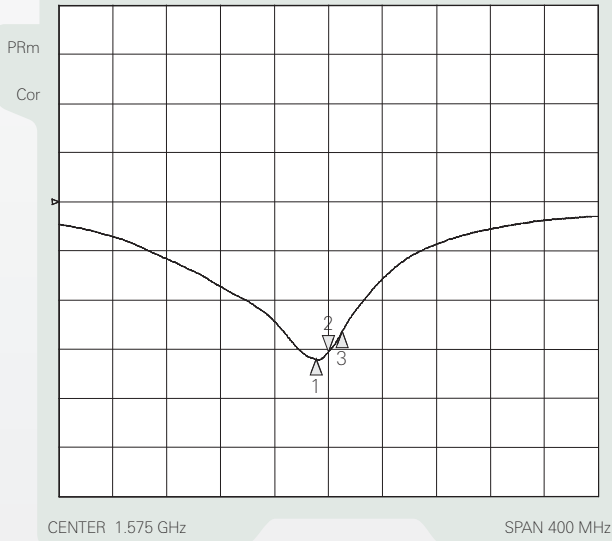

CENTER 1.575 GHz

SPAN 400 MHz

GPS 1.575 GHz #1

24 Feb 2009 12:55:57

- 1. 68.535 Ω 3.1875 Ω 1.56550 GHz
- 2. 66.637 Ω 11.031 Ω 1.1147 nH
- 3. 65.742 Ω 20.102 Ω 1.58500 GHz

CH1 S11&M 1 U FS

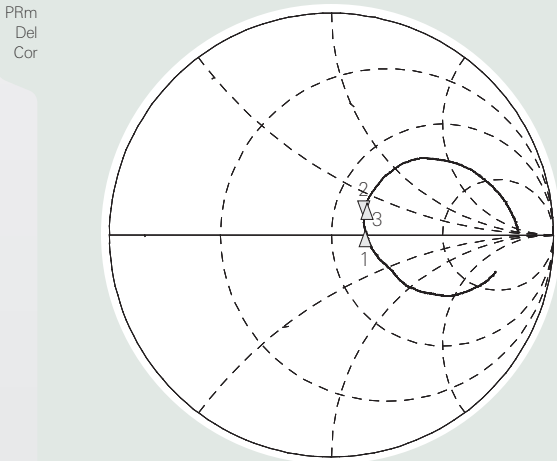

CENTER 1.57500 GHz

SPAN 400 MHz

GPS 1.575 GHz Case #1

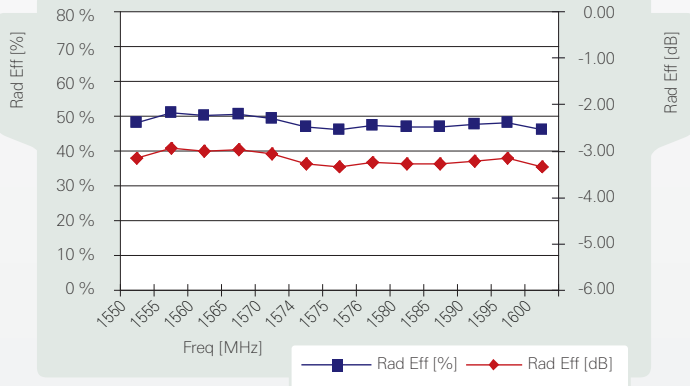

GPS 1.575 GHz Case #1

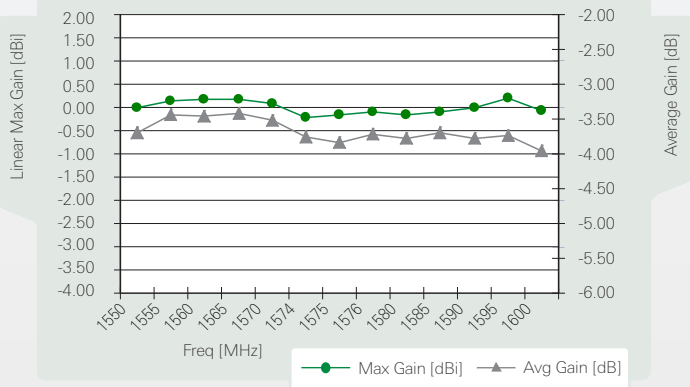

GPS 1.575 GHz Case #1

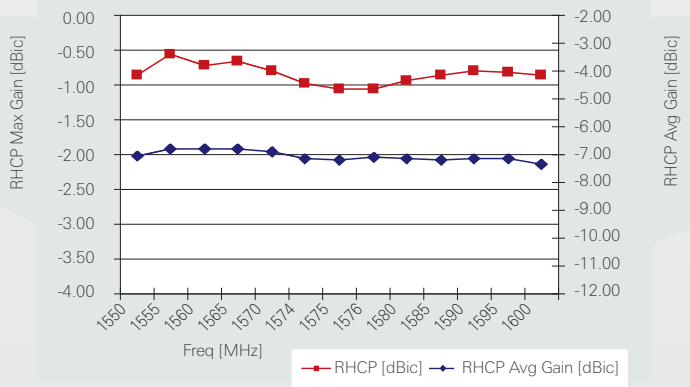

Pulse Finland Oy

Takatie 6
 90440 Kempele, Finland
 Tel: +358 207 935 500
 Fax: +358 207 935 501
www.pulseeng.com/antennas



Ceramic Monopole Antenna

Ground cleared under antenna. Pulse Part Number: W3000

GPS Antenna Case #1

Typical Free Space Radiation Patterns

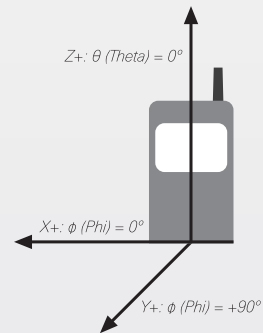
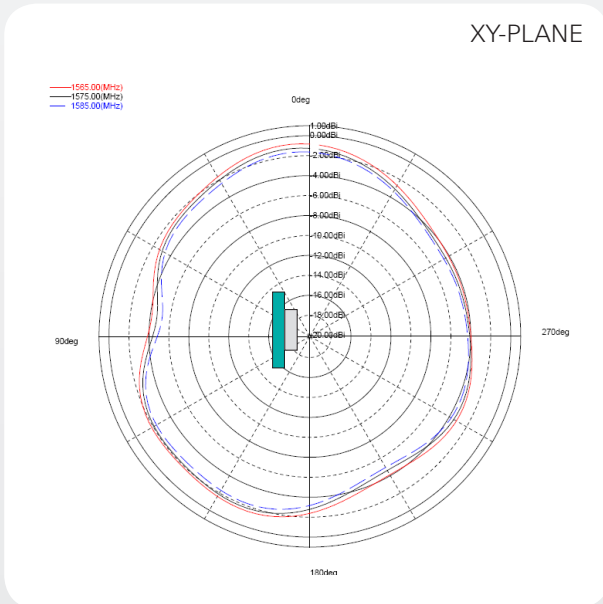
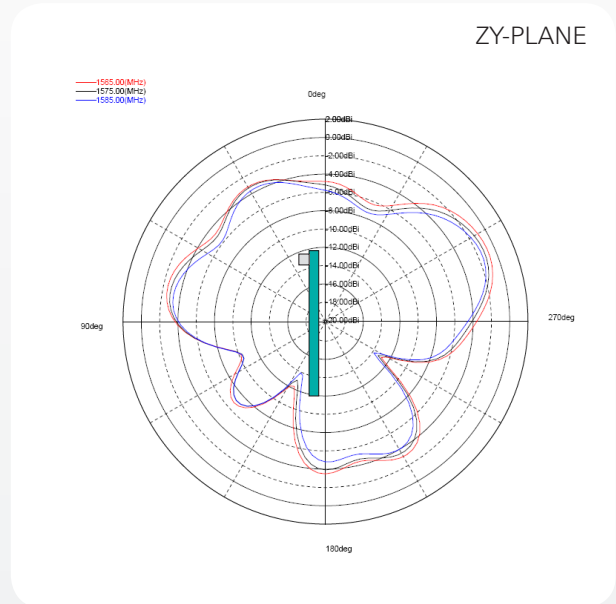
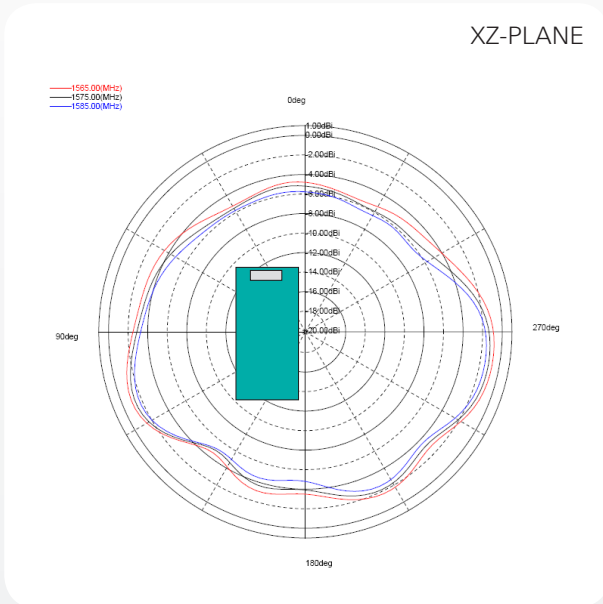

Pulse Finland Oy

Takatie 6
90440 Kempele, Finland
Tel: +358 207 935 500
Fax: +358 207 935 501

www.pulseeng.com/antennas



Ceramic Monopole Antenna

Ground cleared under antenna. Pulse Part Number: W3000

GPS Antenna Case #2

Board Size 20x30

Recommended antenna position on PWB for W3000 MONOPOLE Antenna

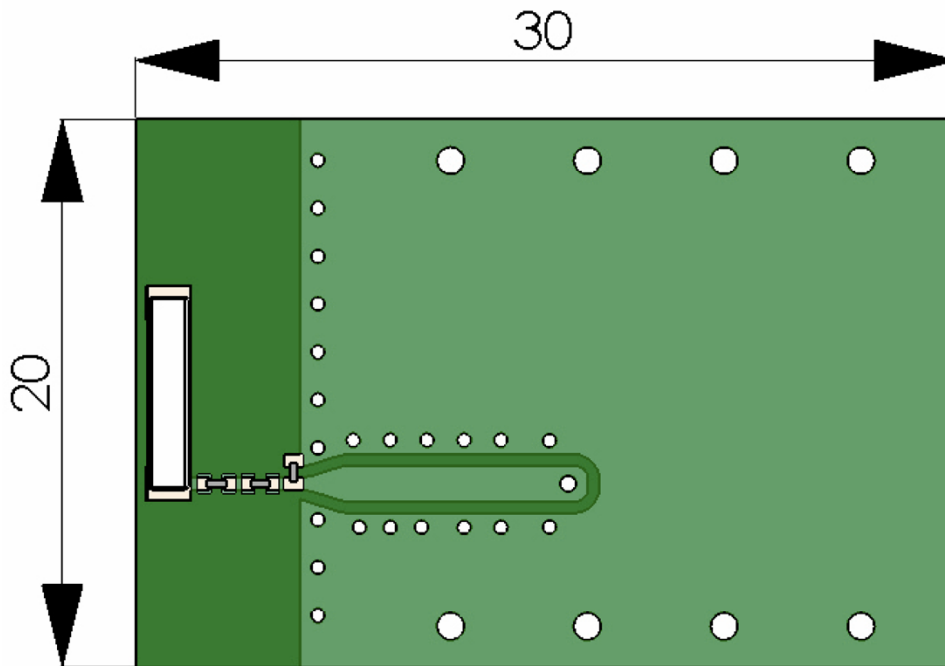

Pulse Finland Oy

Takatie 6
90440 Kempele, Finland
Tel: +358 207 935 500
Fax: +358 207 935 501

www.pulseeng.com/antennas

Ceramic Monopole Antenna

Ground cleared under antenna. Pulse Part Number: W3000

GPS Antenna Case #2, Test Set Up and Measurement Performance

Ground cleared under antenna, clearance area 20.00 x 6.00 mm.

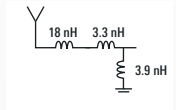

Typical Electrical Characteristics (T=25 °C)

Measured on the 30 x 20 mm test board with matching circuit. Measured in antenna position1 on PWB layout, see previous page. Typical Return Loss S11/ impedance, free space efficiency and gain.

GPS 1.575 GHz Case #2

24 Feb 2009 12:56:26

CH1:Markers

- 1. -19.333 dB 1.56550 GHz
- 2. -22.352 dB 1.57500 GHz
- 3. -17.667 dB 1.58500 GHz

CH1 S11#MLOG 5 dB/REF 0 dB

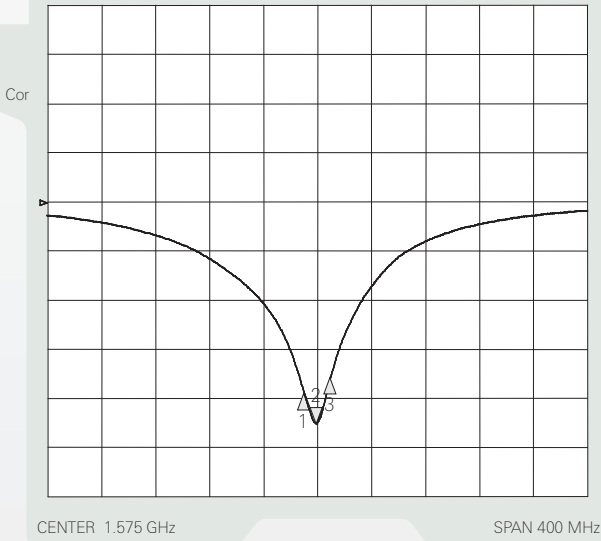

GPS 1.575 GHz #2

24 Feb 2009 12:56:33

- 1. 52.109 Ω -11.057 Ω 1.56550 GHz
- 2. 44.865 Ω -5.4199 Ω 18.644 pF
1.57500 GHz
- 3. 38.271 Ω 0.7773 Ω 1.58500 GHz

CH1 S11#M 1 U FS

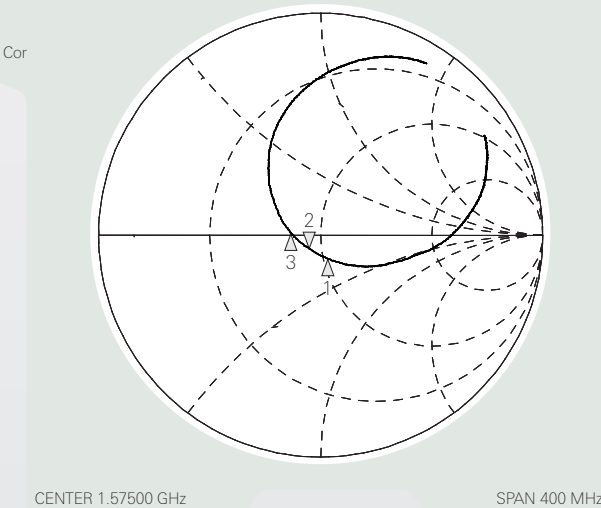

GPS 1.575 GHz Case #2

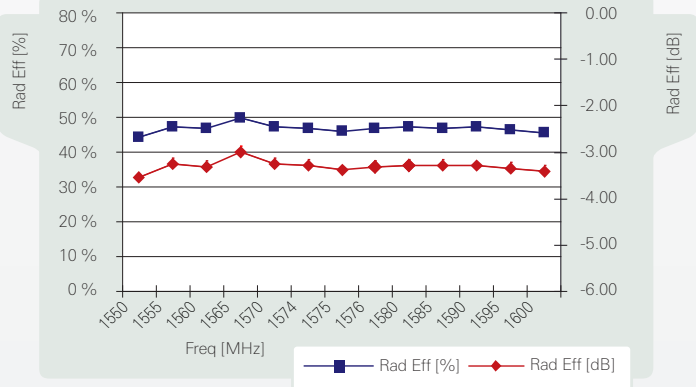

GPS 1.575 GHz Case #2

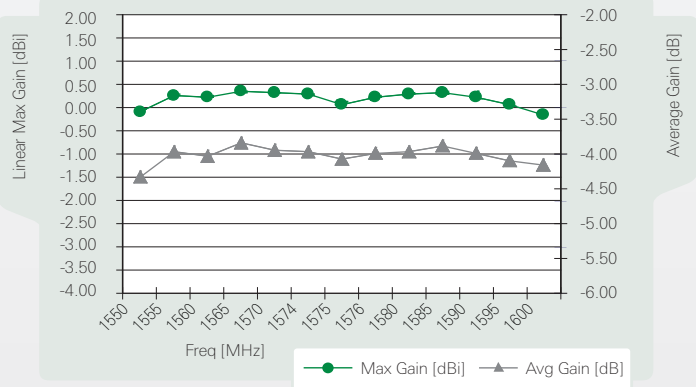

GPS 1.575 GHz Case #2

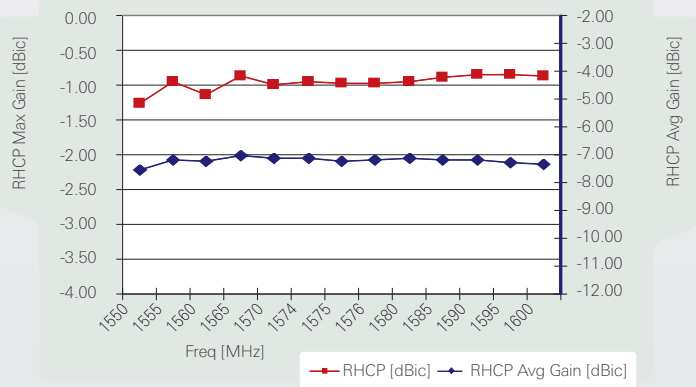

Pulse Finland Oy

Takatie 6
90440 Kempele, Finland
Tel: +358 207 935 500
Fax: +358 207 935 501
www.pulseeng.com/antennas



Ceramic Monopole Antenna

Ground cleared under antenna. Pulse Part Number: W3000

GPS Antenna Case #2

Typical Free Space Radiation Patterns

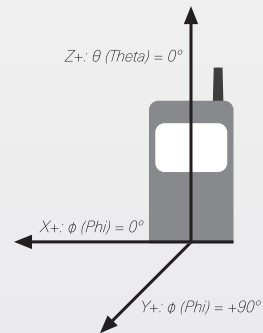
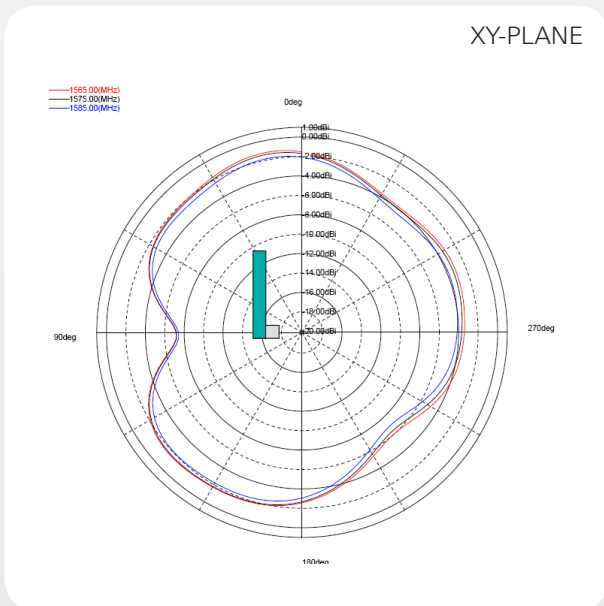
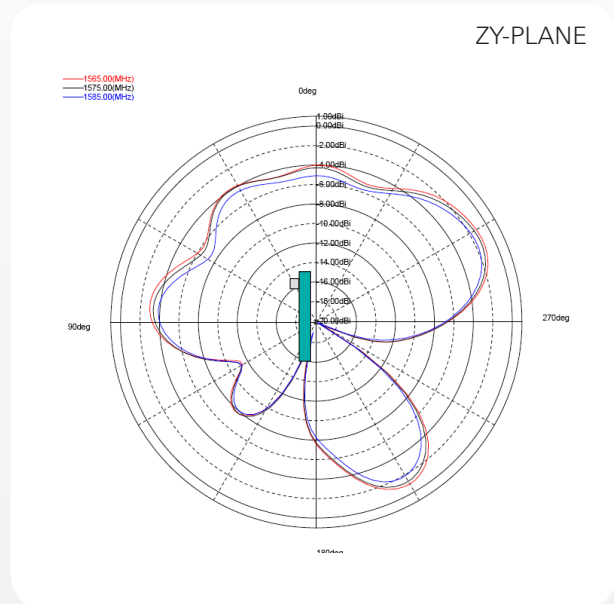
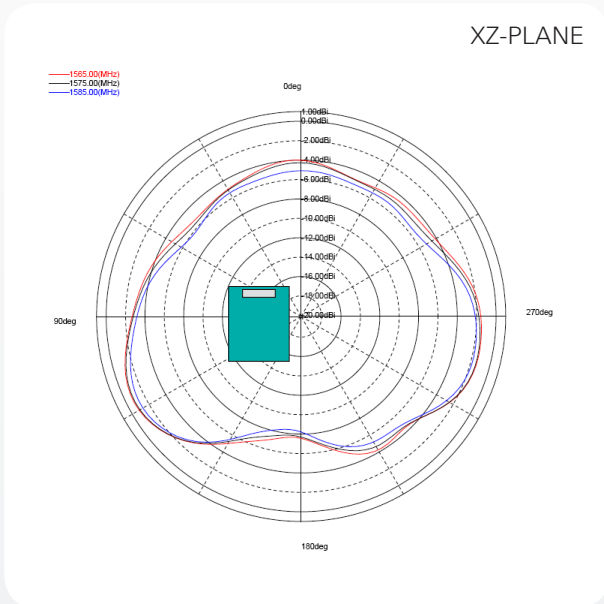

Pulse Finland Oy

Takatie 6
90440 Kempele, Finland

Tel: +358 207 935 500

Fax: +358 207 935 501

www.pulseeng.com/antennas



Ceramic Monopole Antenna

Ground cleared under antenna. Pulse Part Number: W3000

GPS Antenna Case #3

Board Size 37 x 80 mm

Recommended antenna position on PWB for W3000 MONOPOLE Antenna

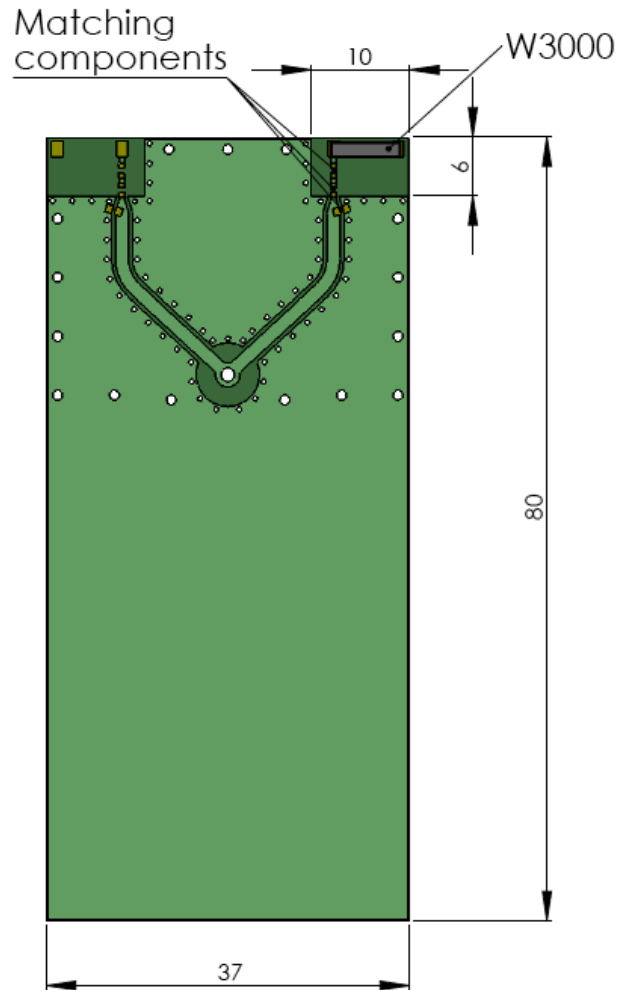

Pulse Finland Oy

Takatie 6
90440 Kempele, Finland
Tel: +358 207 935 500
Fax: +358 207 935 501
www.pulseeng.com/antennas



Ceramic Monopole Antenna

Ground cleared under antenna. Pulse Part Number: W3000

GPS Antenna Case #3, Test Set Up and Measurement Performance

Ground cleared under antenna, clearance area 20.00 x 6.00 mm.

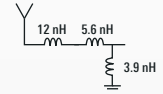

Typical Electrical Characteristics (T=25 °C)

Measured on the 30 x 20 mm test board with matching circuit. Measured in antenna position1 on PWB layout, see previous page. Typical Return Loss S11/ impedance, free space efficiency and gain.

GPS 1.575 GHz Case #3

24 Feb 2009 12:57:25

CH1 Markers

- 1. -19.931 dB 1.56550 GHz
- 2. -25.898 dB 1.57500 GHz
- 3. -24.453 dB 1.58500 GHz

CH1 S11@MLOG 5 dB/REF 0 dB

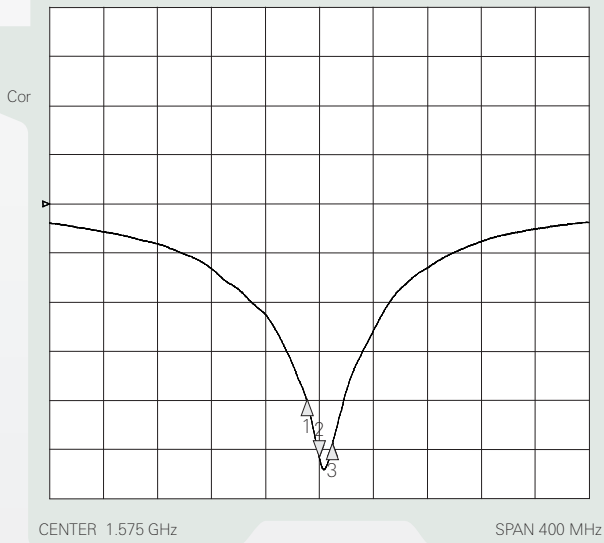

GPS 1.575 GHz Case #3

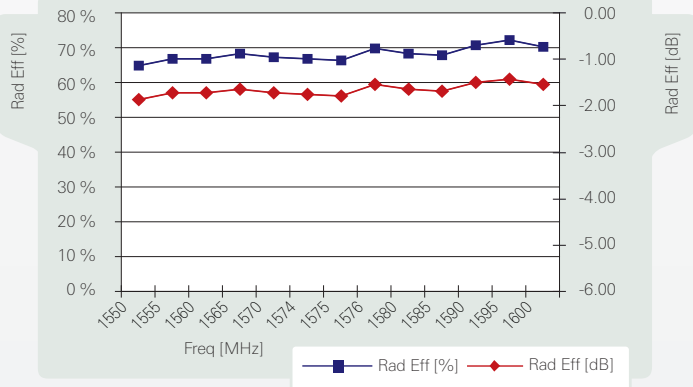

GPS 1.575 GHz Case #3

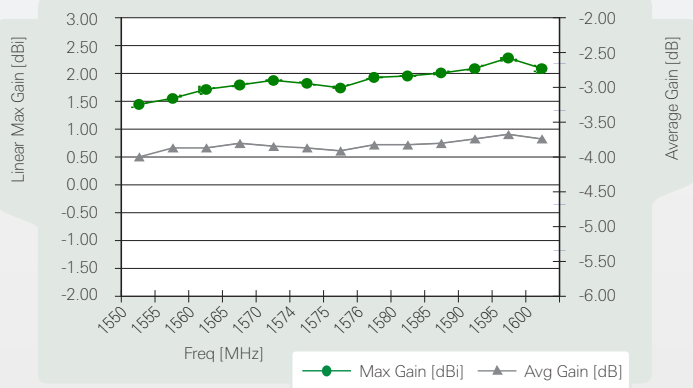

GPS 1.575 GHz #3

24 Feb 2008 12:55:57

- 1. 45.469 Ω -9.8496 Ω 1.56550 GHz
- 2. 44.766 Ω -3.0801 Ω 32.808 pF
- 3. 65.742 Ω 20.102 Ω 1.58500 GHz

CH1 S11@M 1 U FS

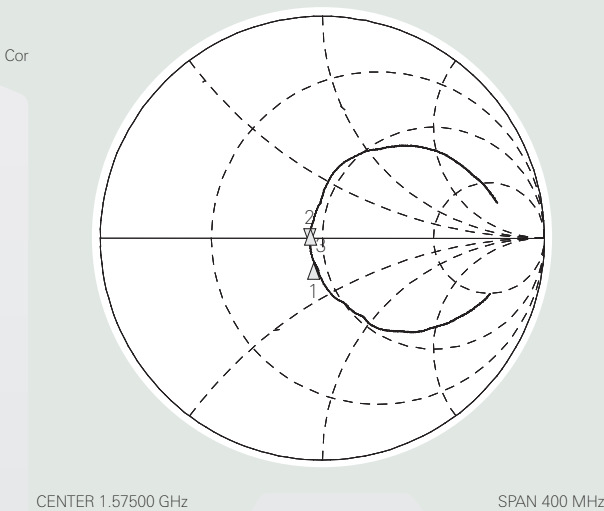

GPS 1.575 GHz Case #3

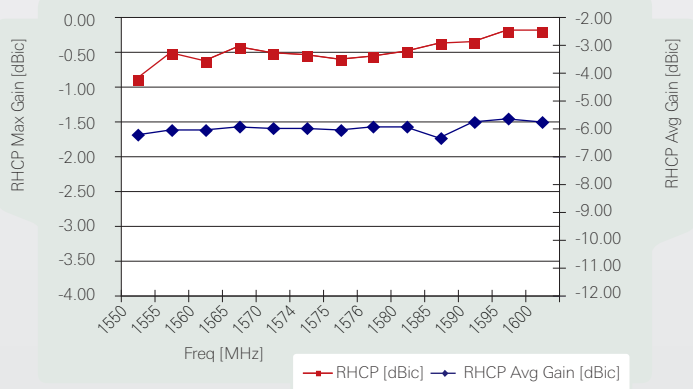

Pulse Finland Oy

Takatie 6
 90440 Kempele, Finland
 Tel: +358 207 935 500
 Fax: +358 207 935 501
www.pulseeng.com/antennas



Ceramic Monopole Antenna

Ground cleared under antenna. Pulse Part Number: W3000

GPS Antenna Case #3

Typical Free Space Radiation Patterns

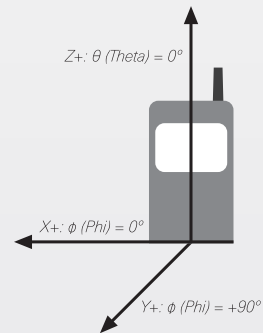
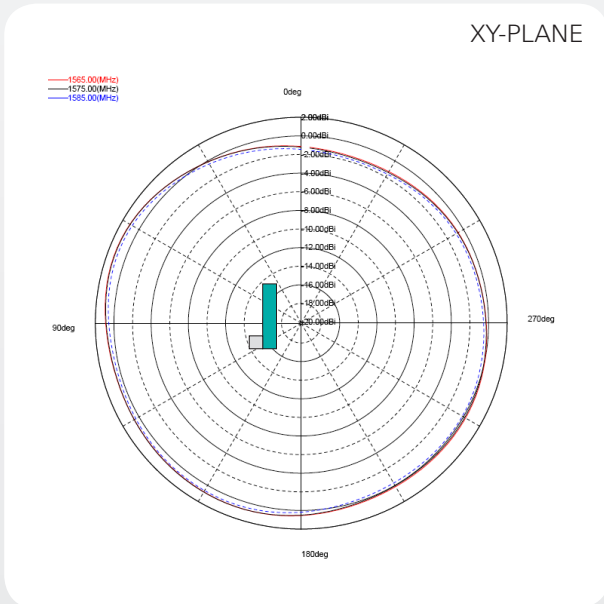
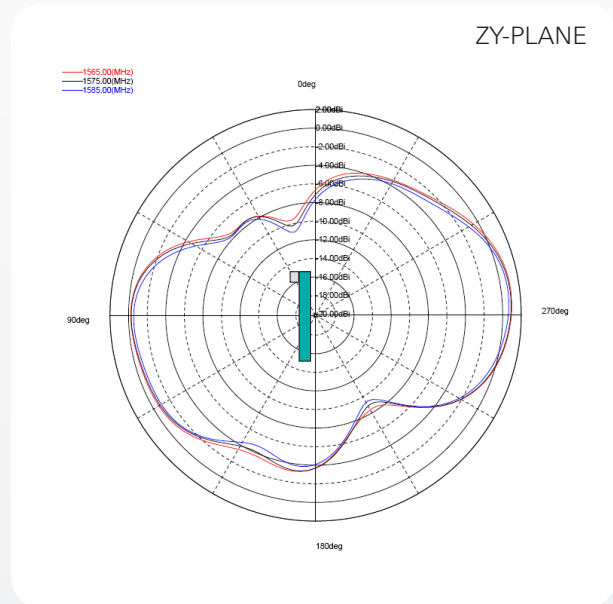
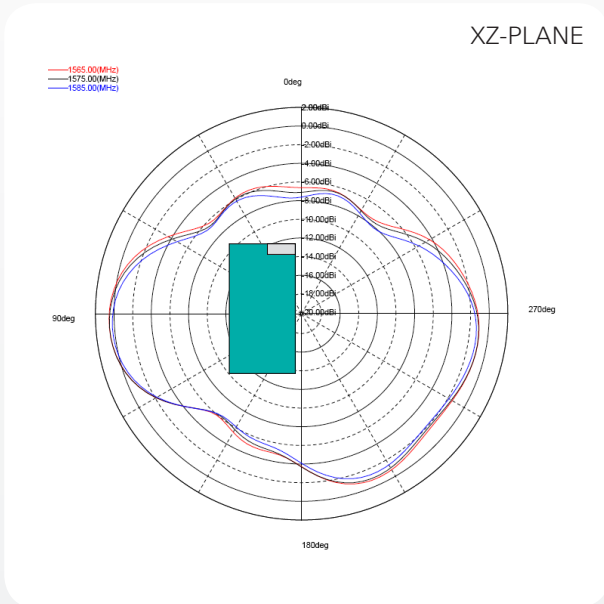

Pulse Finland Oy

Takatie 6
90440 Kempele, Finland

Tel: +358 207 935 500

Fax: +358 207 935 501

www.pulseeng.com/antennas



Ceramic Monopole Antenna

Ground cleared under antenna. Pulse Part Number: W3000

WiFi Antenna Case #1

Board Size 40 x 11 mm

Recommended antenna position on PWB for W3000 MONOPOLE Antenna

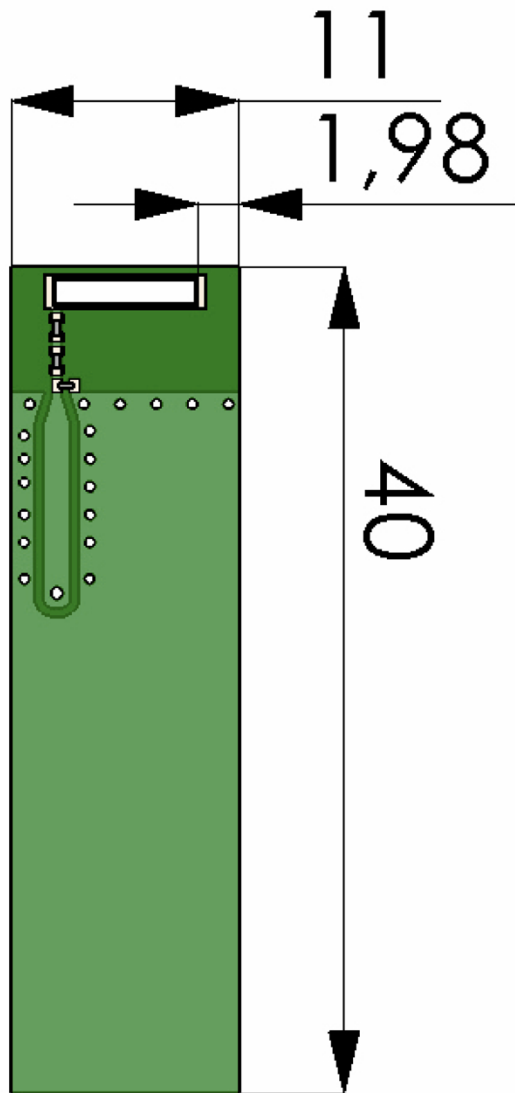

Pulse Finland Oy

Takatie 6
90440 Kempele, Finland
Tel: +358 207 935 500
Fax: +358 207 935 501
www.pulseeng.com/antennas

Ceramic Monopole Antenna

Ground cleared under antenna. Pulse Part Number: W3000

WiFi Antenna Case #1, Test Set Up and Measurement Performance

Ground cleared under antenna, clearance area 11.00 x 6.00 mm.

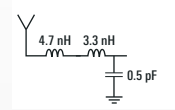

Typical Electrical Characteristics (T=25 °C)

Measured on the 11 x 40 mm test board with matching circuit. Measured in antenna position1 on PWB layout, see previous page. Typical Return Loss S11/ impedance, free space efficiency and gain.

2.4 GHz WiFi Case #1

19 Oct 2008 23:52:24

CH1Markers

- 1. -21.743 dB 2.40000 GHz
- 2. -20.781 dB 2.48000 GHz

CH1 S11 LOG

6 dB/REF 0 dB

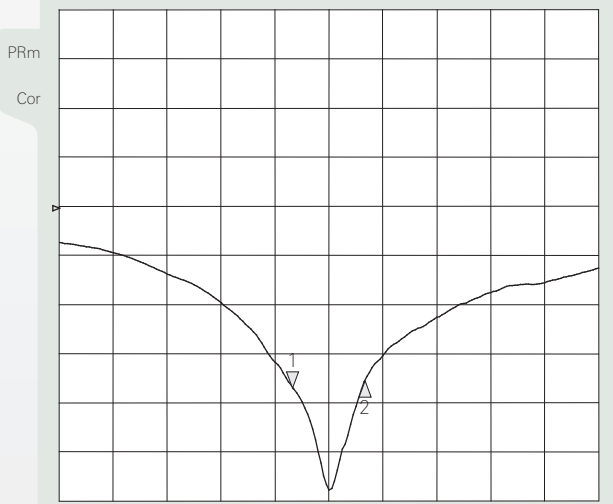

START 2140.000 000 MHz

STOP 2740.000 000 MHz

2.4 GHz WiFi #1

11 Oct 2008 23:52:35

- 1. 58.187 Ω 1.8516 Ω 2.40000 GHz
- 2. 42.477 Ω -4.0078 Ω 2.48000 GHz
- 122.79 pH

CH1 S11 1 U FS

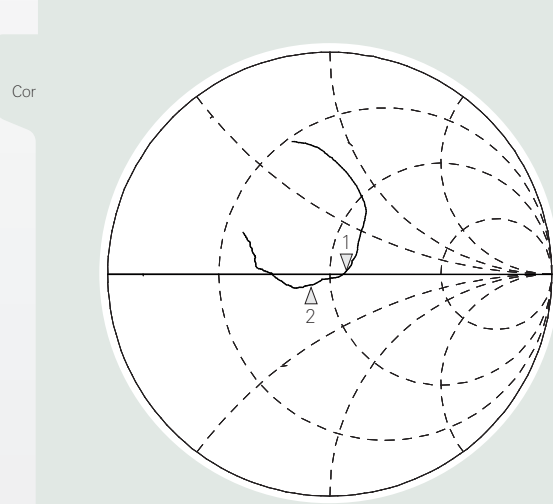

START 2140.000 MHz

STOP 2740.000 MHz

2.4 GHz WiFi Case #1

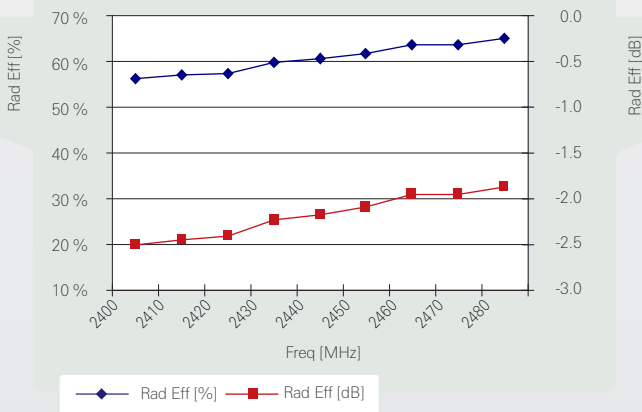

2.4 GHz WiFi Case #1

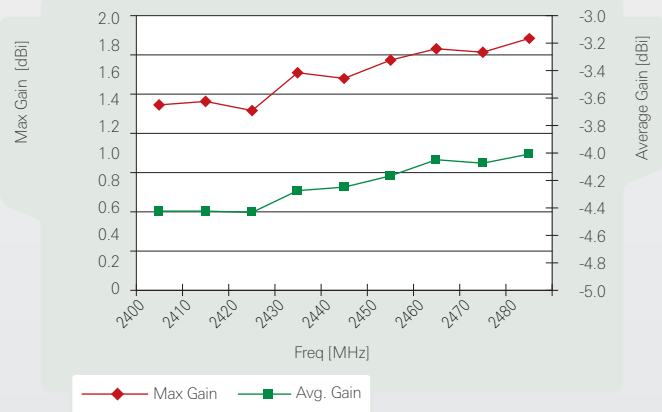

Pulse Finland Oy

Takatie 6
90440 Kempele, Finland
Tel: +358 207 935 500
Fax: +358 207 935 501

www.pulseeng.com/antennas



Ceramic Monopole Antenna

Ground cleared under antenna. Pulse Part Number: W3000

WiFi Antenna Case #1

Typical Free Space Radiation Patterns

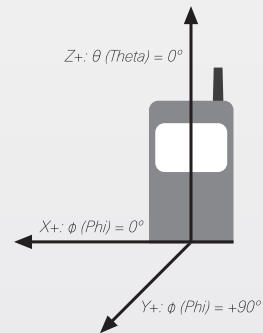
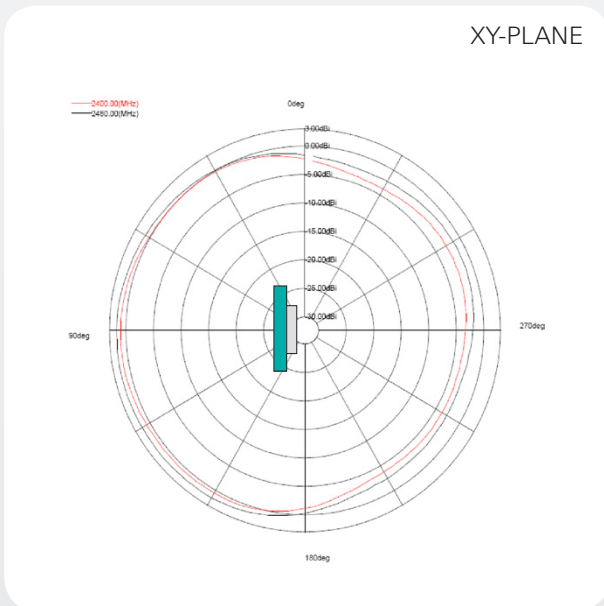
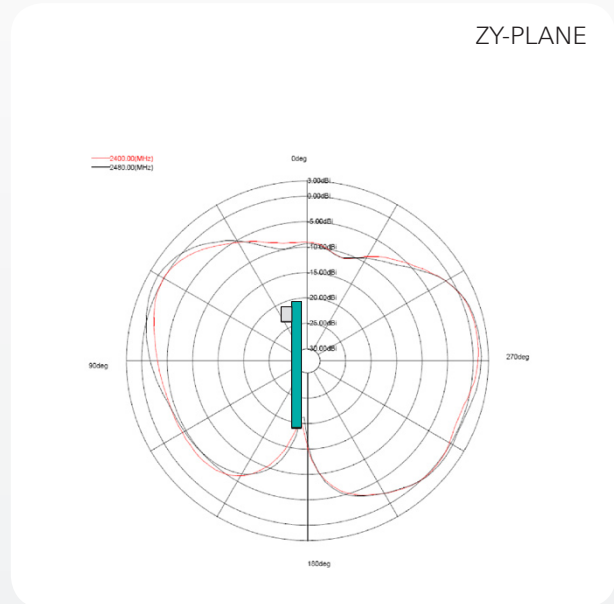
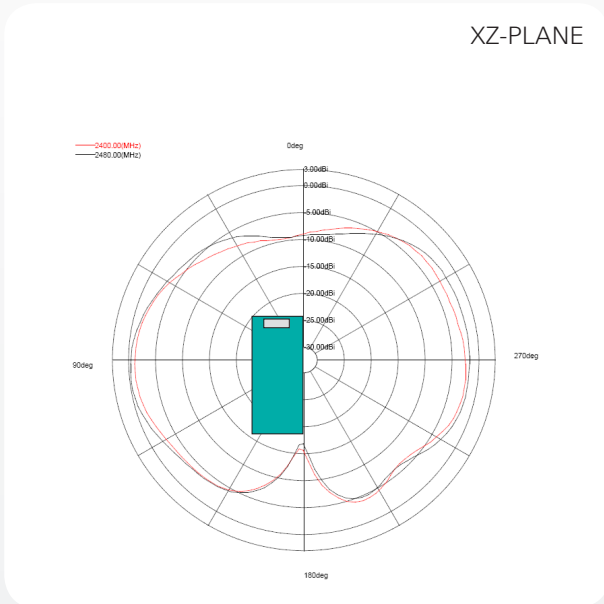

Pulse Finland Oy

Takatie 6
90440 Kempele, Finland
Tel: +358 207 935 500
Fax: +358 207 935 501
www.pulseeng.com/antennas



Ceramic Monopole Antenna

Ground cleared under antenna. Pulse Part Number: W3000

WiFi Antenna Case #2

Board Size 20 x 30 mm

Recommended antenna position on PWB for W3000 MONOPOLE Antenna

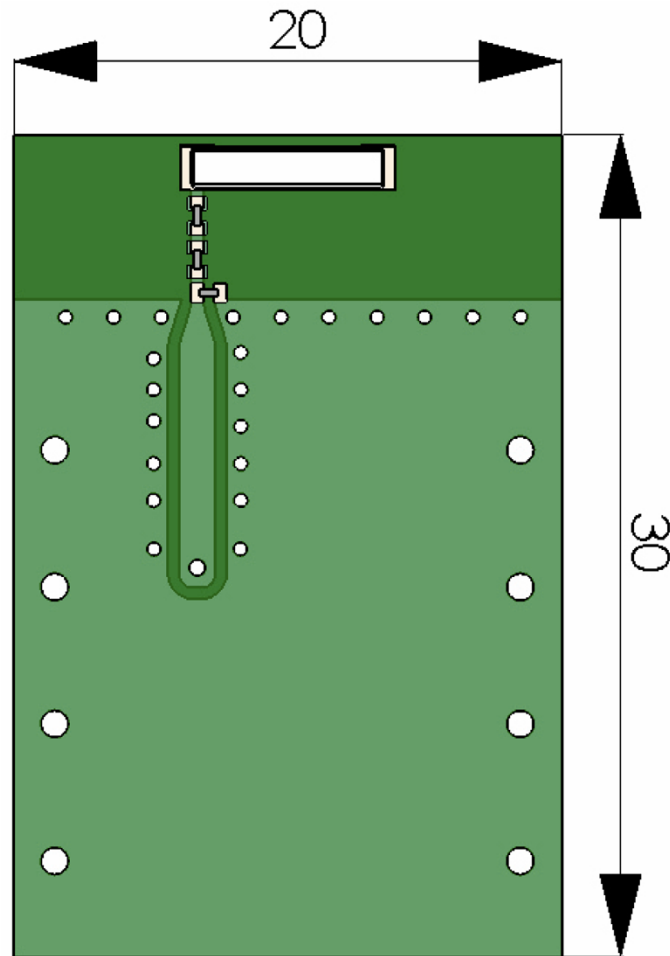

Pulse Finland Oy

Takatie 6
90440 Kempele, Finland

Tel: +358 207 935 500

Fax: +358 207 935 501

www.pulseeng.com/antennas



Ceramic Monopole Antenna

Ground cleared under antenna. Pulse Part Number: W3000

WiFi Antenna Case #2, Test Set Up and Measurement Performance

Ground cleared under antenna, clearance area 20.00 x 6.00 mm.

Typical Electrical Characteristics (T=25 °C)

Measured on the 30 x 20 mm test board with matching circuit. Measured in antenna position1 on PWB layout, see previous page. Typical Return Loss S11/ impedance, free space efficiency and gain.

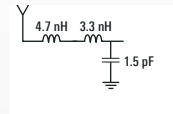

2.4 GHz WiFi Case #2

19 Oct 2008 23:48:18

CH1Markers

- 1. -15.093 dB 2.400 GHz
- 2. -12.933 dB 2.480 GHz

CH1 MLOG 6 dB/REF 0 dB

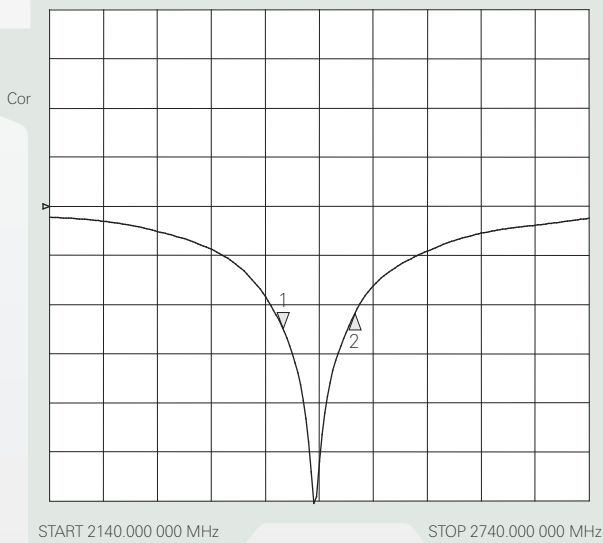

2.4 GHz WiFi #2

11 Feb 2008 11:47:36

CH1Markers

- 1. 51.129 Ω 18.035 Ω 2.40000 GHz
- 2. 36.529 Ω -14.525 Ω 2.48000 GHz
- 1.1960 nH

CH1 S11 1 U FS

Cor

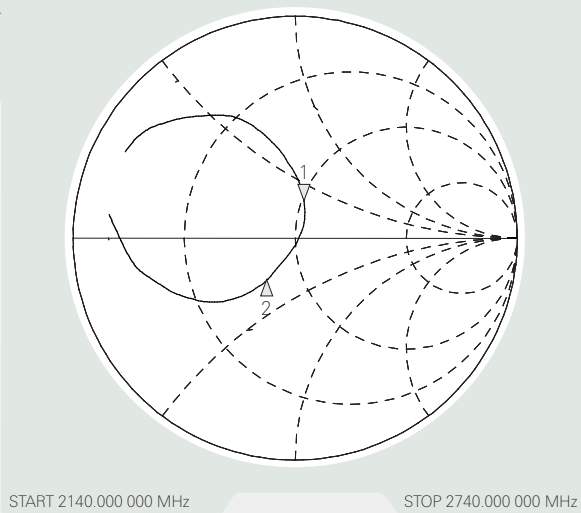

2.4 GHz WiFi Case #2

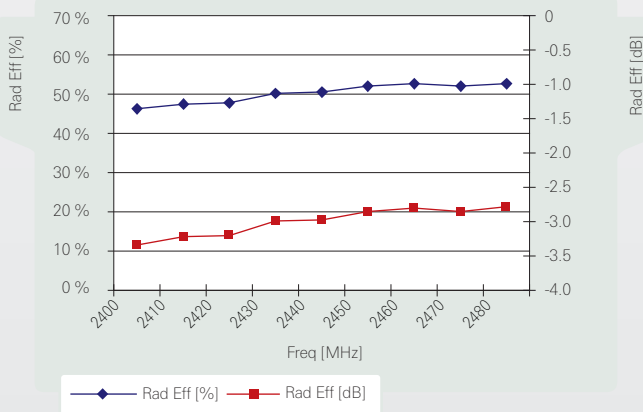

2.4 GHz WiFi Case #2

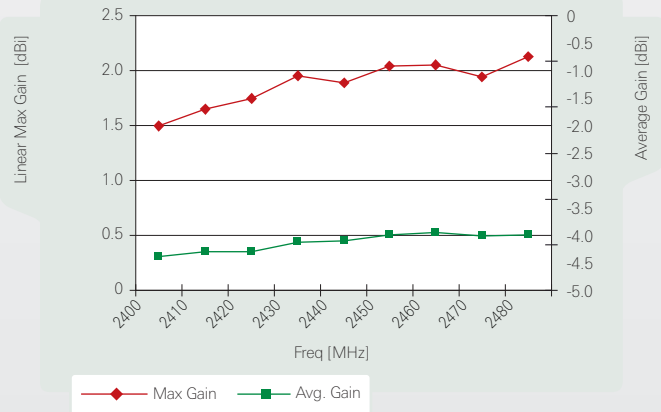

Pulse Finland Oy

Takatie 6
90440 Kempele, Finland
Tel: +358 207 935 500
Fax: +358 207 935 501

www.pulseeng.com/antennas



Ceramic Monopole Antenna

Ground cleared under antenna. Pulse Part Number: W3000

WiFi Antenna Case #2

Typical Free Space Radiation Patterns

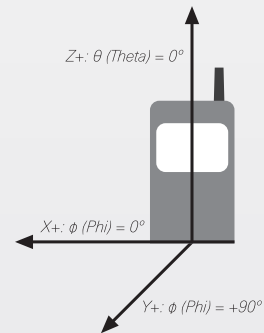
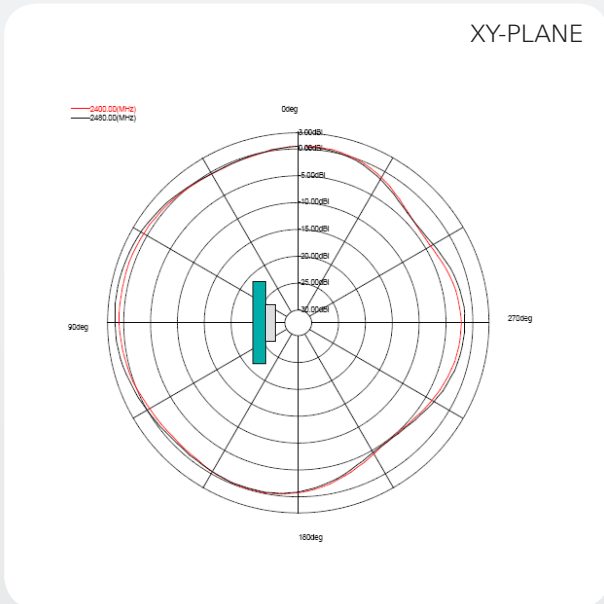
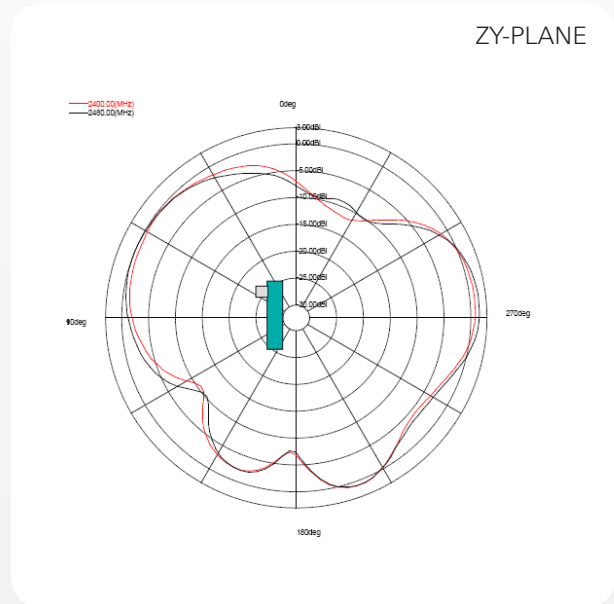
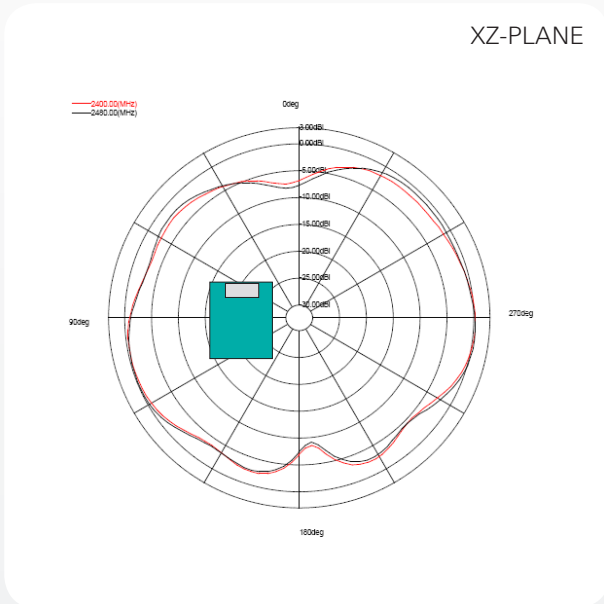

Pulse Finland Oy

Takatie 6
90440 Kempele, Finland
Tel: +358 207 935 500
Fax: +358 207 935 501

www.pulseeng.com/antennas



Ceramic Monopole Antenna

Ground cleared under antenna. Pulse Part Number: W3000

ISM 868 MHz Antenna Case #1

Board Size 20 x 40 mm

Recommended antenna position on PWB for W3000 MONOPOLE Antenna

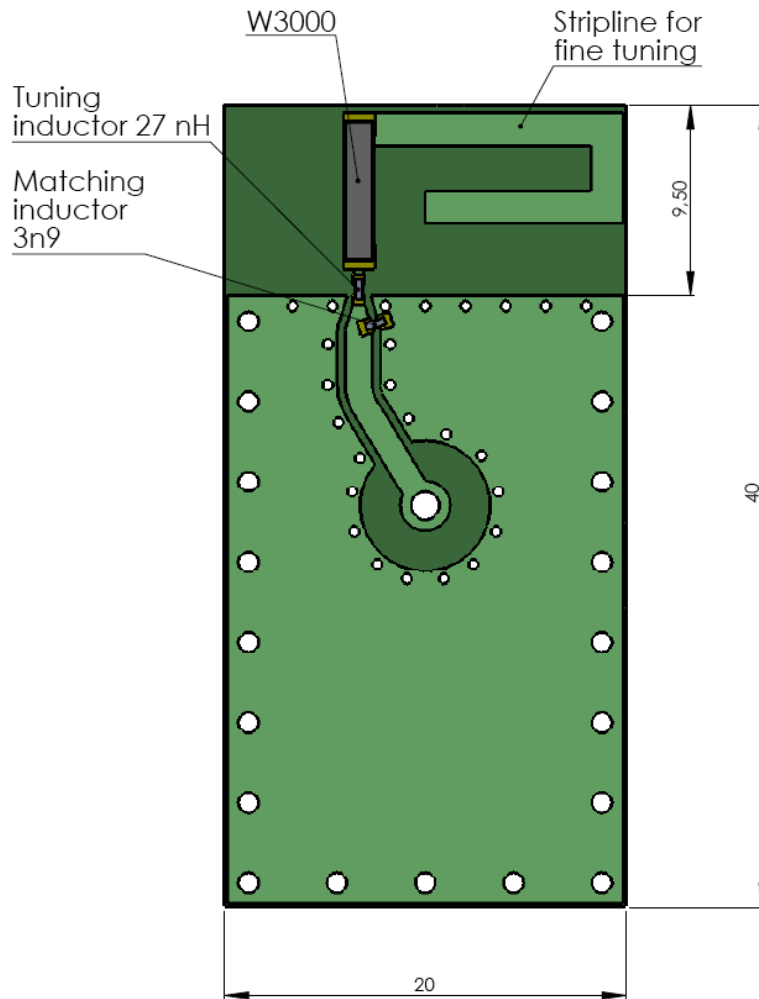

Pulse Finland Oy

Takatie 6
90440 Kempele, Finland
Tel: +358 207 935 500
Fax: +358 207 935 501
www.pulseeng.com/antennas

Ceramic Monopole Antenna

Ground cleared under antenna. Pulse Part Number: W3000

ISM 868 MHz Antenna Case #1, Test Set Up and Measurement Performance

Typical Electrical Characteristics (T=25 °C)

Measured on the 20 x 40 mm test board with matching circuit. Measured in antenna position1 on PWB layout, see previous page. Typical Return Loss S11/ impedance, free space efficiency and gain.

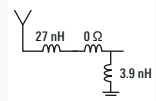

ISM 868 MHz Case #1

24 Mar 2009 16:05:57

CH1 S11&MLOG 5 dB/REF 0 dB

CH1 Markers

- 1. -10.887 dB 858 MHz
- 2. -35.538 dB 868 MHz
- 3. -10.836 dB 878 MHz

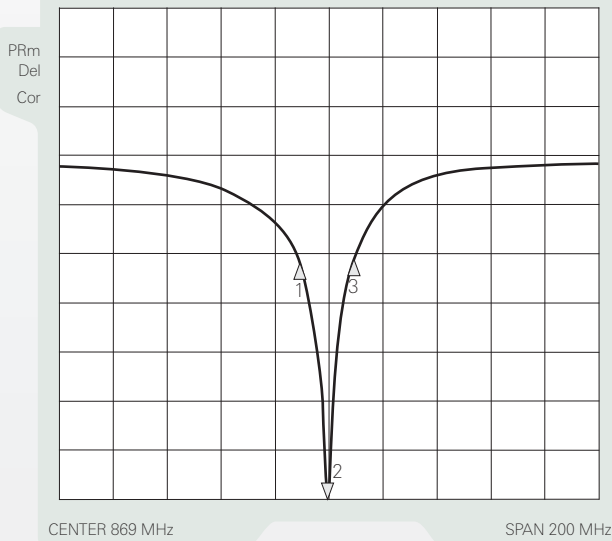

ISM 868 MHz #1

24 Mar 2009 16:06:06

CH1 S11&M 1 U FS

- 1. 90.109 Ω -5.8008 Ω 858 MHz
- 2. 51.600 Ω -1.2168 Ω 150.69 pF 868 MHz
- 3. 29.132 Ω -9.9443 Ω 878 MHz

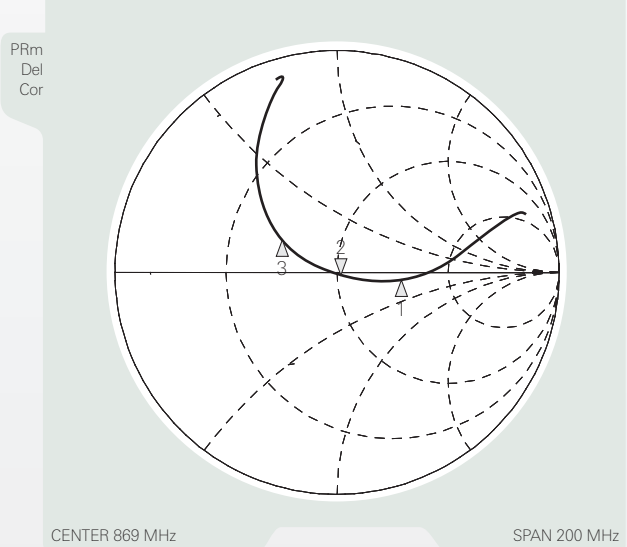

ISM 868 MHz Case #1

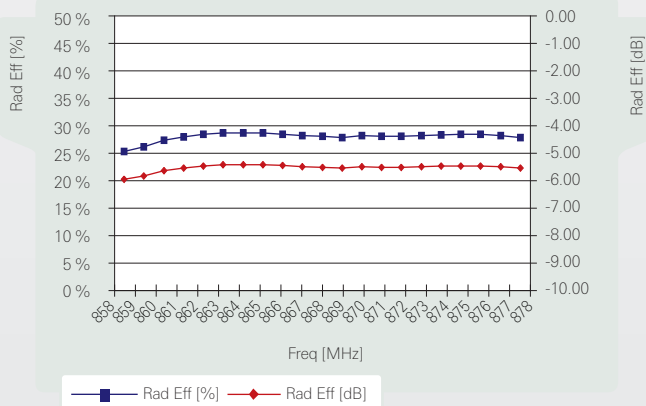

ISM 868 MHz Case #1

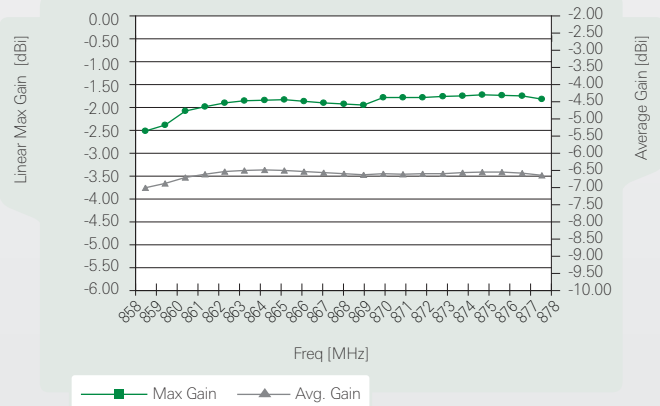

Pulse Finland Oy

Takatie 6
90440 Kempele, Finland
Tel: +358 207 935 500
Fax: +358 207 935 501
www.pulseeng.com/antennas



Ceramic Monopole Antenna

Ground cleared under antenna. Pulse Part Number: W3000

ISM 868 MHz Antenna Case #1

Typical Free Space Radiation Patterns

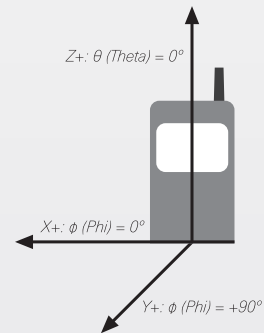
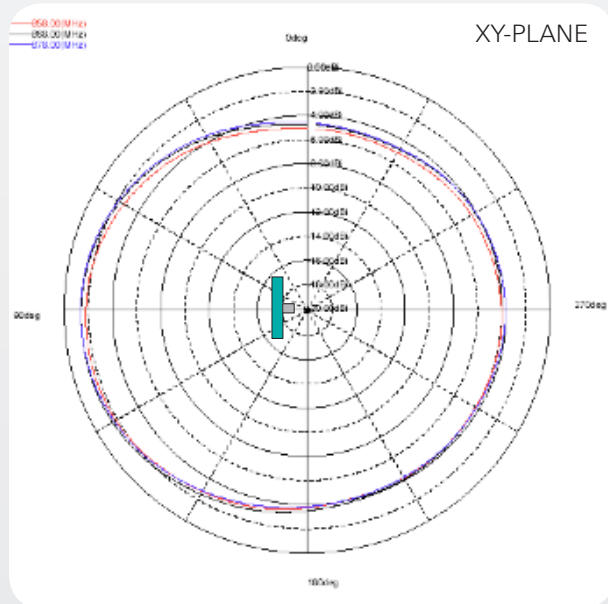
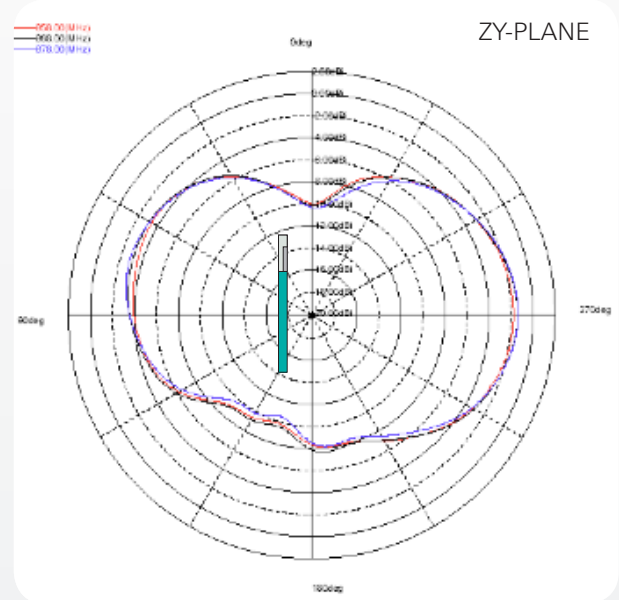
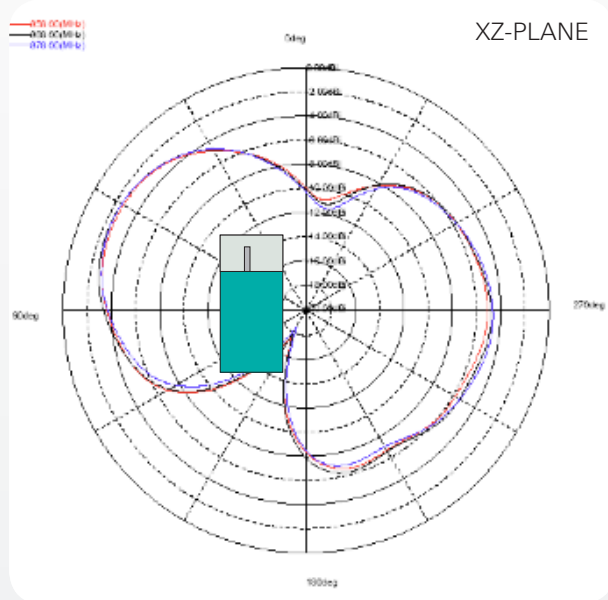

Pulse Finland Oy

Takatie 6
 90440 Kempele, Finland
 Tel: +358 207 935 500
 Fax: +358 207 935 501

www.pulseeng.com/antennas



Ceramic Monopole Antenna

Ground cleared under antenna. Pulse Part Number: W3000

ISM 868 MHz Antenna Case #2

Board Size 20 x 40 mm

Recommended antenna position on PWB for W3000 MONOPOLE Antenna

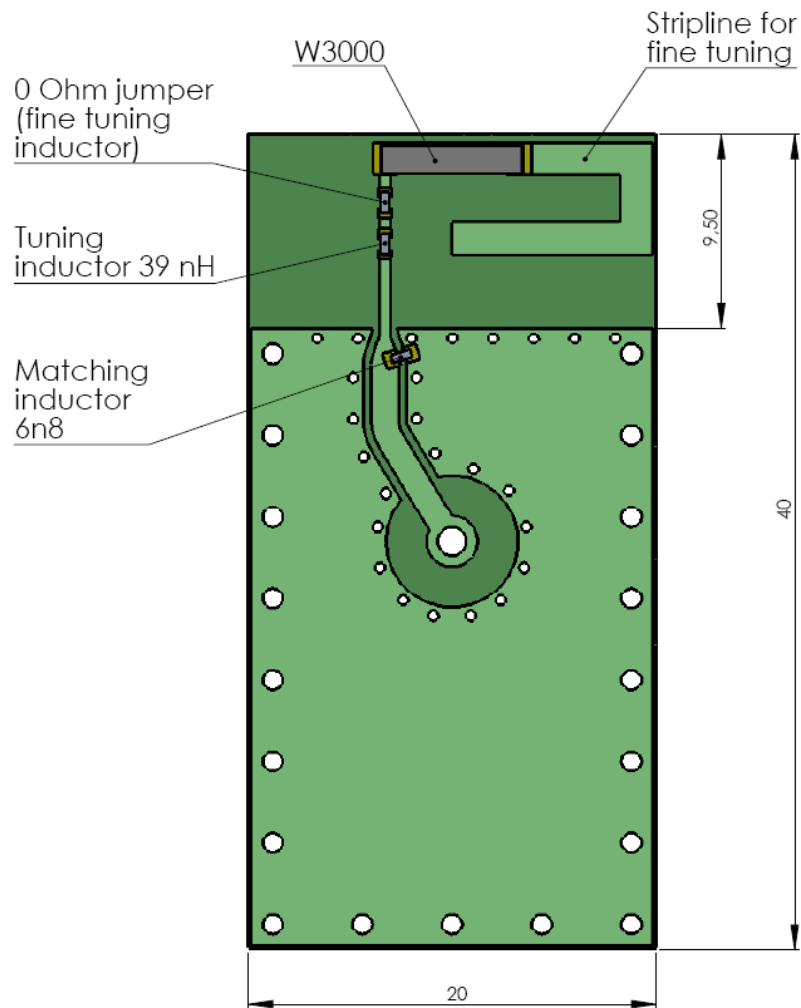

Pulse Finland Oy

Takatie 6
90440 Kempele, Finland

Tel: +358 207 935 500

Fax: +358 207 935 501

www.pulseeng.com/antennas

Ceramic Monopole Antenna

Ground cleared under antenna. Pulse Part Number: W3000

ISM 868 MHz Antenna Case #2

Typical Free Space Radiation Patterns

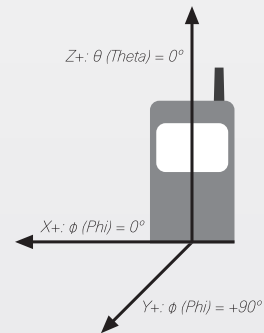
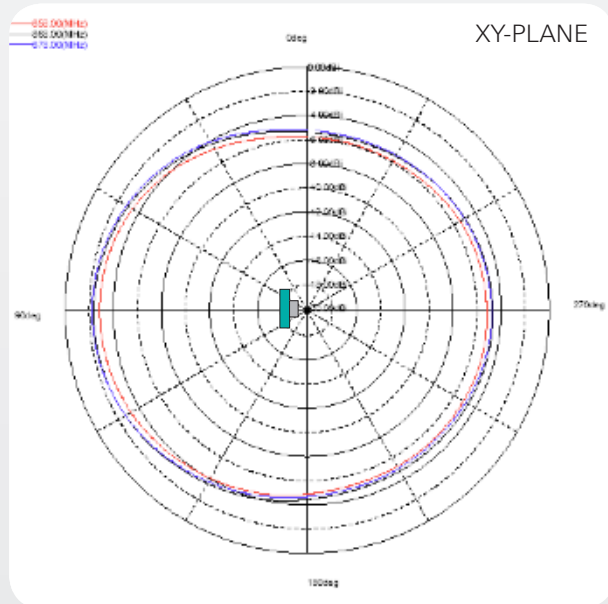
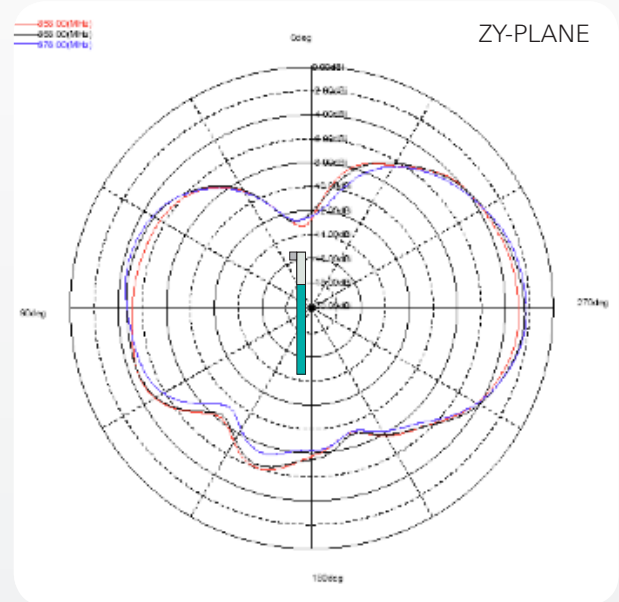
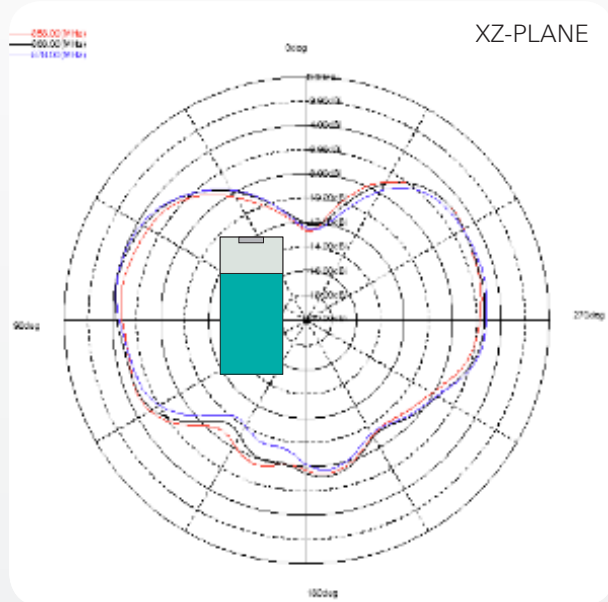

Pulse Finland Oy

Takatie 6
90440 Kempele, Finland
Tel: +358 207 935 500
Fax: +358 207 935 501

www.pulseeng.com/antennas



Ceramic Monopole Antenna

Ground cleared under antenna. Pulse Part Number: W3000

For More Information, Please Contact

Pulse Finland Oy

Takatie 6
FI-90440 Kempele
Finland
Tel. +358 207 935 500
Fax +358 207 935 501 (sales)

Domicile: Kempele
Business ID: 1933992-8
firstnamesurname@pulseeng.com
www.pulseeng.com/antennas

Pulse World Wide Headquarters

12220 World Trade Drive
San Diego, CA 92128
U.S.A.
Tel. +1 858 674 8100
Fax +1 858 674 826
www.pulseeng.com

This is a "Preliminary" product application notes. Products mentioned on this application notes are in development and in the process of being qualified. These products are not fully released nor are they in production. Features, specifications and performance of products offered are subject to change without notice. Other brand and product names mentioned herein may be products and/or registered trademarks of their respective ones. For current info on this product, please contact the Pulse San Diego office. © Copyright, 2009. Pulse Finland Oy. All rights reserved.

Pulse Finland Oy

Takatie 6
90440 Kempele, Finland
Tel: +358 207 935 500
Fax: +358 207 935 501
www.pulseeng.com/antennas

